

Safety Identification



Safety Signs, Pipe Marking, Lockout/Tagout,
Logistics Labelling, Area Marking

About BRADY



Once you have worked with BRADY, our name will stick with you, (just like our labels) because BRADY is one of the world's leading labelling and identification specialists.

Innovative

At BRADY we continue to improve. We have many customers from all industries, and we strive to be ahead of their needs by continuing to invest in research for even more performant solutions. By developing more user-friendly and efficient concepts, we give our thousands of customers the best in the market.

Strength

At BRADY, we believe our biggest strength is the wide range of identification and safety solutions we can offer our customers, whether it's labelling the smallest component or complete signage for an entire warehouse. We're also proud to offer many products and services - from printers, scanners and software to service contracts and on-site training - that compliment any identification job.

And don't forget, our wide network of expert distributors can always offer you a tailor-made solution to meet your specific requirements.

Trust

For almost a hundred years, BRADY has been connected with quality, trust and stability. We demand the best for your products and services, because we know, better than anyone, the importance of good and reliable identification. Identification looks like a small detail, but every professional knows that this kind of detail is crucial to any business.

Inform

We also have specialised dealers in your region, who can answer all your identification and labelling questions, specific to your activity. They will be happy to provide you with all kinds of options and solutions with no obligation.



Brady products are sold on the condition that the purchaser will test them in actual use and determine for himself/herself their suitability to his/her intended purpose. Brady warrants to the purchaser that Brady products are free from defects in material and workmanship but limits its obligation under this warranty to the replacement of the product which has been shown to Brady's satisfaction to have been defective at the time of its purchase.

The warranty does not extend to any persons who have acquired the product from the purchaser. It is in lieu of any other warranty, including every warranty of sale-ability, marketability or suitability for the intended purpose, and is also in lieu of any other obligation or liability on the part of Brady.

Under no circumstances will Brady be liable for losses, damage, costs or subsequent damage of whatever nature which may arise in connection with the use of, or inability to use, Brady's products.



Safety Signs 3



Pipe Marking 67



Lockout Tagout 85



Logistics Labelling 119



Area Marking 137



Brady material overview 151
Quantity of numbers & letters per pack overview 152
Index 153

More literature from Brady

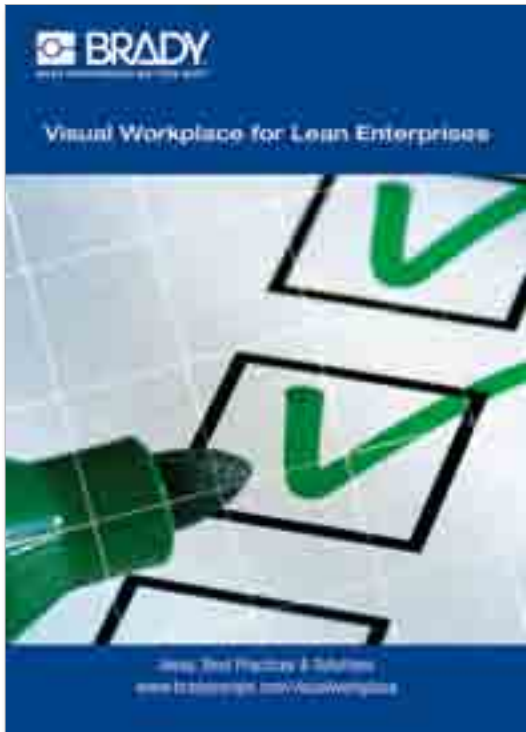
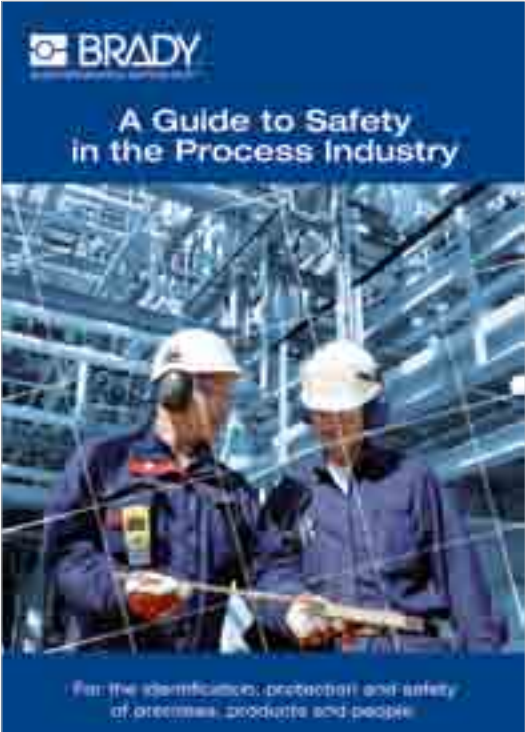

Please contact your local customer services to request our literature.



SAFETY SIGNS

Safety Signs Regulations	4	Prohibition Signs	22	Safety Signs on Rolls – Laminated Polyester	45
Safety Poster	4	Multi-Message Signs	26	Safety Signs on Rolls – Vinyl	46
Material Overview	5	Construction Site Safety Signs	28	Mini-pictograms	47
British Standard Fire Exit & Emergency Escape Signs	6	Harsh Environment Signs	29	Transport Signs	48
Emergency Exit Signs	7	Photoluminescent Signs	30	Maritime Transport Signs	51
Exit & Assembly Signs	8	Wallcharts & Pocket Guides	32	Hazardous Substances Identification	52
General Safe Condition & First Aid Signs	9	Statutory & Information Notices	33	NFPA Placard	53
Fire Equipment Signs	10	Safety Awareness Posters	34	IMO Safety Signs – BradyGlo™	54
Extinguisher Code Signs	11	Reflective Traffic & Works Safety Signs	35	Safety Equipment Storage Solutions	61
Fire Action Mandatory Signs	12	Vandal Resistant Traffic & Property Signs	38	Mounting Systems	62
Mandatory Safety Signs	13	Floor Safety Signs	40	Brady Customize-it: Custom Safety Signs	63
Hazard Warning Signs	17	A3, A4 & A5 Signs	41	Extra Large Safety Signs	66
Explosive Atmosphere Signs	21	Safety Signs A5/A4/A3/A2/A1	43		

Safety Sign Regulations



Safety Signs at work

Safety signs in the workplace are an indispensable way of protecting employees from accidents. Their purpose is to convey information in a comprehensive way about objects and situations that can be dangerous. In case of a fire, for instance, well placed signs can speed up the evacuation of a building and help those giving first aid.

Common dangerous situations are:

- Exposure to harmful substances, gases or vapours.
- Machines being repaired or being in maintenance.
- Marked-out danger zones.
- Danger of falling objects.
- Trip hazards and slippery floors.
- Fast evacuation of contaminated places, etc...

The following methods can be used to reduce the risks of these dangerous situations:

- Safety signs that use symbols or text together with a recognised safety colour.
- Labels that identify products, leads, pipes etc.
- Safety lock systems for valves, installations etc.
- Posts, chains and tapes that can be positioned to indicate dangerous zones.

The psychology of colours

Colours play an important role when it comes to safety signs: they convey a message - and each safety colour has a specific meaning.

The colour of the sign specifies its nature: **red** signs are prohibitive; **blue** signs are mandatory; **yellow** signs are warnings; and **green** is used for safe condition and first aid signs.

Similar rules apply to the different shapes: prohibitive and obligatory signs are circular; warning signs are triangular; and oblong signs offer help and directions. All Brady signs meet these requirements concerning colour and shape.

Shape



Colour

	Prohibition	Fire fighting Equipment
	Caution Danger	
		Safe condition First Aid
	Obligation	Indication Information

Safety Poster

Keeping your employees informed is of vital importance! Use the Brady Safety Poster - it gives a concise overview of current safety signs and their meaning.

Material: PVC 0.2 mm thickness

Size: 630 x 420 mm

Order ref.	Description
258880	PIC 130E

New Standard for Safety Signs – Revised BS 5499-1

The revised BS 5499-1 is to improve the technical representation of safety signs and introduces the following key principle: It recommends the use of upper and lower case lettering – visually impaired people read and understand sentences or single word messages with an initial case letter more clearly e.g.: Warning, Fire Exit etc. All Brady safety signs now comply with this new technical standard!

The Health & Safety (Safety Signs & Signals) Regulations 1996,

put into practice the European Safety Signs Directive (92/58/EEC). Designed to standardise safety signs reducing the risk of misunderstandings arising from geographical differences across the European community.

How does it affect you?

All employers must use a safety sign where a risk would otherwise go uncontrolled. All safety signs should contain a pictorial symbol.

Safety signs now encompass other safety identification by means of pipe and valve marking, audible signals and illuminated signs.

The regulations encourage the increased use of symbols and this includes all fire safety signs. Use of Brady Safety Signs will mean all of your signs comply with all current British and European Legislation.



Self-adhesive Vinyl

Light-weight, flexible material is ideal for use in offices, light industrial factories, warehouses, standard indoor and dry outdoor environments when applied to a clean, dry, smooth surface.

- Excellent resistance to water, oil, grease
- Permanent, acrylic based, pressure sensitive adhesive
- **Safety colours:** red, black, yellow, green and blue
- **Thickness:** 0.105 mm



Self-adhesive Laminated Polyester

- Signs are printed on polyester using thermal transfer technology
- Protected by clear polyester laminate
- Permanent, acrylic based, pressure sensitive adhesive
- Excellent adhesion to low surface energy surfaces, such as polypropylene and ABS, as well as most powder coatings
- Resistance:
 - most chemical products and solvents
 - extreme temperatures: -40°C up to 140°C
 - very good weatherability and UV resistance
 - good scratch resistance due to the polyester laminate
- **Safety colours:** red, black, yellow, green and blue
- **Thickness:** 0.124 mm



Rigid plastic

- PVC signs are surface printed
- Can be used for a wide variety of applications both indoors and outdoors
- PVC bends easy when it has been heated, allowing us to shape it into projecting signs, which keep there new shape ones they have cooled down
- **Thickness:** 1.5 mm



Aluminium transport sign in holder

Aluminium

- Polyester sign stuck onto a rigid aluminium plate
- Has the same qualities as the standard polyester
- Thickness: 1.5 mm



Polypropylene

- Rigid sign screenprinted on slightly textured polypropylene or laminated polyester stuck onto the rigid polypropylene
- Can be used for a wide variety of applications both indoors and outdoors
- Well suited for especially harsh environments
- Resistance:
 - most chemical products and solvents
 - very good weatherability and UV resistance
- Considered to be an environmentally friendly material
- **Thickness:** 1.5 mm



BRADY^{GL}™ Photoluminescent material

- PVC signs in standard photoluminescent material
- The standard version has a luminous intensity that is 80% higher than the DIN (Deutsche Industry Norm) requires.
- **Thickness:** 1 mm

British Standard Fire Exit & Emergency Escape Signs



- Brady offers a comprehensive range of safe condition signs which help you comply with current legislation.
- Choose from 2 quality materials:
 - Self-adhesive vinyl is a flexible material ideal for use on any smooth, indoor surface.
 - Rigid plastic measures 1.5 mm thick for extra durability (fixings required)
- Can't find the sign that suits your workplace? No problem! Simply call Brady Customer Service who will be happy to help.



Designed to clearly identify escape routes / emergency exits. Conforms to Health & Safety (Safety Signs & Signals) Regulations 1996.

Pictogram	Size mm h x w	Self Adhesive Vinyl Order Ref.	Rigid Plastic Order Ref.
-----------	------------------	-----------------------------------	-----------------------------

Fire exit / running man right / arrow up



150 x 450	701173	701172
250 x 850	702311	702310

Fire exit / running man right / arrow right



150 x 450	701098	701097
250 x 850	701100	701099

Arrow down left / running man left / fire exit



150 x 450	701175	701174
-----------	--------	--------

Fire exit / running man right / arrow up



125 x 525	701179	701178
250 x 850	702315	702314

Fire exit / running man right / arrow right



125 x 525	701199	701198
250 x 850	701201	701200

Fire exit / running man right / arrow down right



125 x 525	701241	701240
-----------	--------	--------

Man running left / fire exit



125 x 525	701215	701214
250 x 850	701217	701216

Running man / Fire exit / Keep clear



150 x 600	701116	701115
150 x 450	701114	701113

Pictogram	Size mm h x w	Self Adhesive Vinyl Order Ref.	Rigid Plastic Order Ref.
-----------	------------------	-----------------------------------	-----------------------------

Fire exit / running man right / arrow down



150 x 450	701090	701089
250 x 850	701092	701091

Arrow left / running man left / fire exit



150 x 450	701094	701093
250 x 850	701096	701095

Fire exit / running man right / arrow right down



150 x 450	701177	701176
-----------	--------	--------

Fire exit / running man right / arrow down



125 x 525	701243	701242
250 x 850	701245	701244

Arrow left / running man left / fire exit



125 x 525	701207	701206
250 x 850	701209	701208

Arrow left / running man left / fire exit / running man right / arrow right



125 x 525	701181	701180
250 x 850	701183	701182

Fire exit / running man right



125 x 525	701211	701210
250 x 850	701213	701212

Exclamation / Fire exit / Keep clear



300 x 600	701112	701111
-----------	--------	--------

BRADY
Customize-it

See page 63 for information on how to order a customized sign



All Brady Signs are available in your local language. Contact Brady Customer Service for more information

Emergency Exit Signs

Pictogram	Size mm h x w	Self Adhesive Vinyl Order Ref.	Rigid Plastic Order Ref.
-----------	------------------	-----------------------------------	-----------------------------

Running man left / fire exit



150 x 300 701227 701226

Pictogram	Size mm h x w	Self Adhesive Vinyl Order Ref.	Rigid Plastic Order Ref.
-----------	------------------	-----------------------------------	-----------------------------

Fire exit/ running man right



150 x 300 701223 701222
250 x 350 701221 701220

Running man left / exit



200 x 600 701120 701119

Exit / running man right



200 x 600 701122 701121

Running man right / arrow down



150 x 300 701104 701103

Running man right / arrow up



150 x 300 701185 701184

Running man right / arrow right



150 x 300 701108 701107

Arrow left / running man left



150 x 300 701106 701105

Arrow



125 x 125 701195 701194
250 x 250 701197 701196



A supplementary directional arrow sign may only be used with an escape route sign or other safe condition sign.

Running man right symbol



125 x 125 701237 701236

Running man left symbol



125 x 125 701239 701238



Exit & Assembly Signs

BRADY
Customize-it

See page 63 for information on
how to order a customized sign

Pictogram	Size mm h x w	Self Adhesive Vinyl Order Ref.	Rigid Plastic Order Ref.
-----------	---------------------	--------------------------------------	--------------------------------

Push - vertical



150 x 40	701132	-
----------	--------	---

Pictogram	Size mm h x w	Self Adhesive Vinyl Order Ref.	Rigid Plastic Order Ref.
-----------	---------------------	--------------------------------------	--------------------------------

Pull - vertical



150 x 40	701133	-
----------	--------	---

Turn left to open



125 x 125	702294	702293
-----------	--------	--------

Turn right to open



125 x 125	702296	702295
-----------	--------	--------

In case of emergency break glass bolt to open



50 x 100	702229	702230
----------	--------	--------

In case of fire break glass



100 x 200	701135	701134
-----------	--------	--------

Push bar to open



50 x 250	701127	701126
150 x 600	701128	701129

Assembly point - number



300 x 250	701189	701188
-----------	--------	--------

Add (1-9) after the Order Reference.

Assembly point - letter



300 x 250	701189	701188
-----------	--------	--------

Add (A-I) after the Order Reference.

Fire assembly point



250 x 350	701225	701224
-----------	--------	--------

Your fire assembly point is...

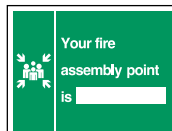

250 x 350	701141	701140
-----------	--------	--------

Emergency assembly point



250 x 350	701139	701138
-----------	--------	--------

Emergency assembly point



250 x 250	702292	702291
-----------	--------	--------

Safe area

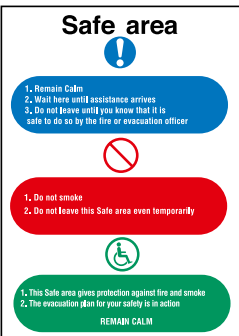

300 x 250	701145	701144
-----------	--------	--------

Disabled symbol / Safe area



250 x 350	701187	701186
-----------	--------	--------

General Safe Condition & First Aid Signs

Pictogram	Size mm h x w	Self Adhesive Vinyl Order Ref.	Rigid Plastic Order Ref.
-----------	---------------------	--------------------------------------	--------------------------------

Eye wash



250 x 200 701152 701151

Pictogram	Size mm h x w	Self Adhesive Vinyl Order Ref.	Rigid Plastic Order Ref.
-----------	---------------------	--------------------------------------	--------------------------------

Emergency shower



250 x 200 701150 701149

Drinking water



75 x 50 701165* -

Cigarette symbol / smoking area



250 x 350 701137 701136

First aid room



250 x 200 701160 701159

First aid box



250 x 200 701158 701157

First aid station



250 x 200 701164 701163

First aid



250 x 200 701156 701155

First aiders are



250 x 200 701162 701161

Cross symbol (square)



250 x 200 701154 701153

The nearest first aid box is situated / person in charge

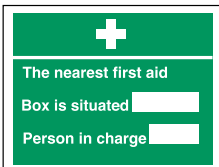

250 x 300 701167 701166

Your first aider is / located at



250 x 300 701169 701168

First aid for this department is available from



250 x 300 701171 701170

Emergency stop push button



300 x 250 701080 701079

*10 signs per pack

Fire Equipment Signs

BRADY
Customize-it

See page 63 for information on how to order a customized sign

SAFETY SIGNS

Pictogram	Size mm h x w	Self Adhesive Vinyl Order Ref.	Rigid Plastic Order Ref.
-----------	---------------	--------------------------------	--------------------------

Fire extinguisher



250 x 250 701058 701057

Fire hydrant



200 x 250 701054 701053

Fire alarm



250 x 250 701067 701068

Fire point



250 x 250 701049 701050

Fire extinguisher



300 x 250 701059 701060

Not for use on electrical fires



100 x 200 701064 701063

Fire extinguisher



100 x 200 701061 701062

Fire point



100 x 200 701072 701071

Pictogram	Size mm h x w	Self Adhesive Vinyl Order Ref.	Rigid Plastic Order Ref.
-----------	---------------	--------------------------------	--------------------------

CO₂



200 x 250 701056 701055

Water extinguisher



200 x 250 701076 701075

Dry riser



200 x 250 701078 701077

Fire alarm call point



300 x 250 701073 701074

Fire hose reel



300 x 250 701051 701052

For use on electrical fires



100 x 200 701066 701065

Fire alarm



100 x 200 701070 701069

Emergency stop push button



75 x 50 701146*
250 x 200 701148 701147

*10 signs per pack



Help ensure the correct choices are made when fighting a fire

- Position these signs near to all your fire extinguisher stations to help staff understand which is the correct extinguisher to use.
- Comply with the Health and Safety (Safety Signs & Signals) Regulations 1996, BSEN3 Regulations & BS5499 Safety Sign Standards.

Pictogram	Size mm h x w	Self Adhesive Vinyl Order Ref.	Rigid Plastic Order Ref.
-----------	---------------	--------------------------------	--------------------------

Know your fire extinguisher colour code

300 x 450	702053	702052
250 x 300	702051	702050

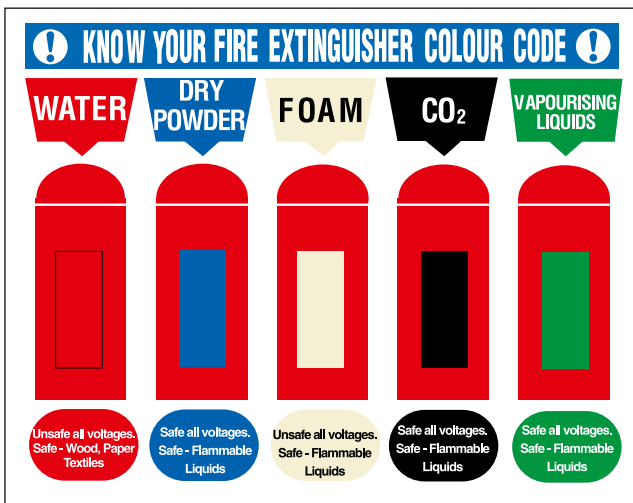

Pictogram	Size mm h x w	Self Adhesive Vinyl Order Ref.	Rigid Plastic Order Ref.
-----------	---------------	--------------------------------	--------------------------

Dry powder – Safe – all voltages and flammable liquids

100 x 300	702057	702056
-----------	--------	--------

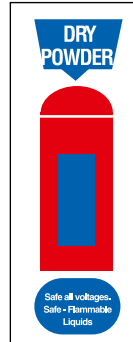

Water – Safe – wood, paper and textiles

100 x 300	702055	702054
-----------	--------	--------

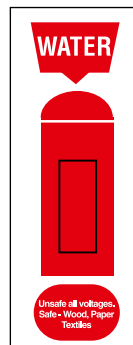

Foam – Safe – flammable liquids

100 x 300	702059	702058
-----------	--------	--------

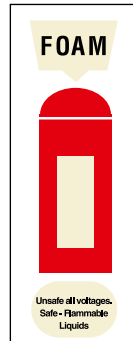

CO2 – Safe – all voltages and flammable liquids

100 x 300	702061	702060
-----------	--------	--------

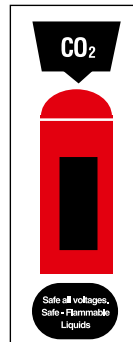

All Brady Signs are available in your local language. Contact Brady Customer Service for more information



Fire Action Mandatory Signs – You must do

Pictogram	Size mm h x w	Self Adhesive Vinyl Order Ref.	Rigid Plastic Order Ref.
-----------	---------------------	--------------------------------------	--------------------------------

Automatic fire door Keep clear

	100 x 100	701045	701046

Keep locked shut

	100 x 100	701009	701008

Keep this door closed

	100 x 100	701048	701047

This door to be kept shut when not in use

	200 x 200	701044	701043

Keep clear Fire escape

	250 x 200	701029	701028
	300 x 250	701027	701026

Keep this area clear of all obstructions

	300 x 250	701021	701020

This stairway and exit to be kept clear

	200 x 600	701035	701034

Pictogram	Size mm h x w	Self Adhesive Vinyl Order Ref.	Rigid Plastic Order Ref.
-----------	---------------------	--------------------------------------	--------------------------------

Fire door keep shut

	100 x 100	701005	701004
	200 x 200	701007	701006

This door must be kept closed

	100 x 100	701013	701012
	200 x 200	701010	701011

Fire escape Keep clear

	100 x 100	701017	701016
	200 x 200	701015	701014

Keep shut Fire door

	150 x 125	701023	701022

Keep clear

	250 x 200	701031	701030

Exit from emergency escape route Keep clear

	300 x 250	701033	701032

BRADY
Customize-it

See page 63 for information on how to order a customized sign



Mandatory Safety Signs

You must follow these instructions

- The Health and Safety (Safety Signs and Signals) Regulations 1996 details that Mandatory Signs must have a blue circular background which contains a white pictogram.
- These signs display a message or action that must be carried out within a designated area.
- Choose from 2 quality materials. Self-adhesive vinyl is a flexible material ideal for use on any smooth, indoor surface. Rigid plastic measures 1.5mm thick for extra durability (fixings required).
- Can't find the sign that suits your workplace? No problem! Simply call Brady Customer Service who will be happy to help.

Pictogram	Size mm h x w	Self Adhesive Vinyl Order Ref.	Rigid Plastic Order Ref.
-----------	---------------------	--------------------------------------	--------------------------------

Wash hands



150 x 125	701499	701500
-----------	--------	--------

Pictogram	Size mm h x w	Self Adhesive Vinyl Order Ref.	Rigid Plastic Order Ref.
-----------	---------------------	--------------------------------------	--------------------------------

Now wash your hands please



150 x 125	701475	701474
300 x 250	701477	701476

Health and safety at work act 1974

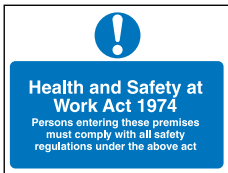

250 x 350	701469	701468
-----------	--------	--------

Waste material



75 x 50	701478*	-
---------	---------	---

Wear seat belts



150 x 125	701519	701520
-----------	--------	--------

Multi-message – No unauthorised access



600 x 450	701490	701489
-----------	--------	--------

Multi-message – Fire action



250 x 200	701003	701002
300 x 250	701001	701000

Multi-message – First aid



250 x 200	701482	701481
300 x 250	701480	701479

Multi-message – Fire action



250 x 200	701039	701040
300 x 250	701038	701037
600 x 450	701042	701041

Fire door keep shut – vertical



450 x 40	701036	-
----------	--------	---



All Brady Signs are available in your local language. Contact Brady Customer Service for more information

*10 signs per pack

Mandatory Safety Signs – You must do

BRADY
Customize-it

See page 63 for information on how to order a customized sign

Pictogram	Size mm h x w	Self Adhesive Vinyl Order Ref.	Rigid Plastic Order Ref.
-----------	---------------------	--------------------------------------	--------------------------------

Use guard

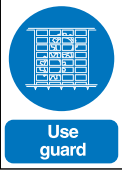
	75 x 50	701507*	–
-----------------------------------------------------------------------------------	---------	---------	---

Stack correctly

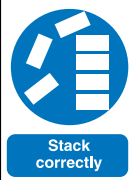
	300 x 250	701526	701525
-----------------------------------------------------------------------------------	-----------	--------	--------

Keep locked

	75 x 50	701509*	–
-----------------------------------------------------------------------------------	---------	---------	---

Sound horn

	300 x 250	701495	701496
-------------------------------------------------------------------------------------	-----------	--------	--------

Would all visitors please report to reception

	250 x 350	701536	701535
-------------------------------------------------------------------------------------	-----------	--------	--------

Permit to work must be obtained

	250 x 350	701537	701538
-------------------------------------------------------------------------------------	-----------	--------	--------

Multi-message – Escalator safety

	250 x 350	701543	701544
-------------------------------------------------------------------------------------	-----------	--------	--------

Pictogram	Size mm h x w	Self Adhesive Vinyl Order Ref.	Rigid Plastic Order Ref.
-----------	---------------------	--------------------------------------	--------------------------------

Lift correctly

	300 x 250	701523	701524
-----------------------------------------------------------------------------------	-----------	--------	--------

Pedestrians must use this route

	300 x 250	701522	701521
-----------------------------------------------------------------------------------	-----------	--------	--------

Drive slowly

	300 x 250	701529	701530
-----------------------------------------------------------------------------------	-----------	--------	--------

Wear safety harness

	150 x 125 300 x 250	701493 701491	701494 701492
-------------------------------------------------------------------------------------	------------------------	------------------	------------------

All visitors and drivers must report to reception

	250 x 350	701486	701485
--------------------------------------------------------------------------------------	-----------	--------	--------

This area must be kept clear of all obstructions

	300 x 250	701484	701483
-------------------------------------------------------------------------------------	-----------	--------	--------

Wear dust mask

	150 x 125	701505	701506
-------------------------------------------------------------------------------------	-----------	--------	--------

*10 signs per pack

Mandatory Safety Signs – You must do

Pictogram	Size mm h x w	Self Adhesive Vinyl Order Ref.	Rigid Plastic Order Ref.
-----------	---------------------	--------------------------------------	--------------------------------

Safety helmets must be worn in this area

	150 x 125	701445	701444
	300 x 250	701447	701446

Head protection must be worn

	300 x 250	701497	701498
-----------------------------------------------------------------------------------	-----------	--------	--------

Ear protection zone / Ear protectors must be worn in this area

	250 x 300	701439	701438
	450 x 600	701441	701440

Ear protectors must be worn in this area

	150 x 125	701435	701434
	300 x 250	701437	701436

Hearing protection must be worn

	150 x 125	701539	701540
	300 x 250	701541	701542

High noise levels Use ear protectors

	150 x 125	701426	701427
	300 x 250	701429	701428

Ear protection must be worn in this area

	150 x 125	701459	701458
	300 x 250	701461	701460
	600 x 450	701463	701462



Pictogram	Size mm h x w	Self Adhesive Vinyl Order Ref.	Rigid Plastic Order Ref.
-----------	---------------------	--------------------------------------	--------------------------------

Wear hard hats

	300 x 250	701443	701442
-----------------------------------------------------------------------------------	-----------	--------	--------

Safety helmets must be worn at all times on this site

	300 x 250	701449	701448
-------------------------------------------------------------------------------------	-----------	--------	--------

Ear protectors symbol

	125 x 125	701531	701532
-------------------------------------------------------------------------------------	-----------	--------	--------

Wear ear protectors

	150 x 125	701423	701422
	300 x 250	701425	701424

Wear ear protectors when operating this machine

	150 x 125	701430	701431
	300 x 250	701432	701433



All Brady Signs are available in your local language. Contact Brady Customer Service for more information

Mandatory Safety Signs – You must do

Pictogram	Size mm h x w	Self Adhesive Vinyl Order Ref.	Rigid Plastic Order Ref.
-----------	---------------------	--------------------------------------	--------------------------------

Eye protection must be worn

	150 x 125	701513	701515
	300 x 250	701514	701516

Wear face shield

	150 x 125	701501	701502
	300 x 250	701503	701504

Wear gloves

	150 x 125	701470	701471
-----------------------------------------------------------------------------------	-----------	--------	--------

Protective footwear must be worn in this area

	300 x 250	701473	701472
-------------------------------------------------------------------------------------	-----------	--------	--------

All visitors must wear personal protective equipment on this site

	250 x 350	701453	701452
-------------------------------------------------------------------------------------	-----------	--------	--------

Wear protective clothing

	300 x 250	701518	701517
-------------------------------------------------------------------------------------	-----------	--------	--------

High visibility clothing must be worn in this area

	300 x 250	701528	701527
-------------------------------------------------------------------------------------	-----------	--------	--------

Pictogram	Size mm h x w	Self Adhesive Vinyl Order Ref.	Rigid Plastic Order Ref.
-----------	---------------------	--------------------------------------	--------------------------------

Goggles symbol

	50 x 50	701510*	–
	125 x 125	701511	701512

Wear goggles

	150 x 125	701455	701454
	300 x 250	701457	701456

Multi-message – Wear eye protection

	250 x 350	701488	701487
------------------------------------------------------------------------------------	-----------	--------	--------

Hand protection must be worn

	150 x 125	701418	701419
	300 x 250	701421	701420

Foot protection must be worn

	300 x 250	701467	701466
-------------------------------------------------------------------------------------	-----------	--------	--------

Approved personal protective equipment must be worn at all times

	300 x 250	701451	701450
-------------------------------------------------------------------------------------	-----------	--------	--------

Lab coats must be worn in this area

	150 x 125	701464	701465
-------------------------------------------------------------------------------------	-----------	--------	--------

*10 signs per pack



Hazard Warning Signs

Identify and warn visitors and staff of potential hazards

- The Health and Safety (Safety Signs and Signals) Regulations 1996 state that Hazard Signs must be displayed to warn people to be careful or to take precautions where hazards exist.
- Choose from 2 quality materials. Self-adhesive vinyl is a flexible material ideal for use on any smooth, indoor surface. Rigid plastic measures 1.5-mm thick for extra durability (fixings required).
- Can't find the sign that suits your workplace? No problem! Simply call Brady Customer Service who will be happy to help.

Pictogram	Size mm h x w	Self Adhesive Vinyl Order Ref.	Rigid Plastic Order Ref.
-----------	------------------	-----------------------------------	-----------------------------

Caution Corrosive substance



150 x 125	701740	701741
300 x 250	701742	701743

Pictogram	Size mm h x w	Self Adhesive Vinyl Order Ref.	Rigid Plastic Order Ref.
-----------	------------------	-----------------------------------	-----------------------------

Danger Acid



150 x 125	701710	701711
-----------	--------	--------

Caustic



200 x 600	701789	701790
-----------	--------	--------

Acid



200 x 600	701791	701792
-----------	--------	--------

Harmful Chemicals



150 x 125	701797	701798
300 x 250	701800	701799

Caution Asbestos



200 x 200	701744	701745
150 x 125	701746	701747

Caution Chemical store



250 x 200	701785	701786
-----------	--------	--------

Danger Highly flammable gases



300 x 250	701705	701704
-----------	--------	--------

Danger Highly flammable liquid



300 x 250	701707	701706
-----------	--------	--------

Danger Highly flammable store



300 x 250	701709	701708
-----------	--------	--------

Hazard Warning Signs

BRADY
Customize-it

See page 63 for information on how to order a customized sign

Pictogram	Size mm h x w	Self Adhesive Vinyl Order Ref.	Rigid Plastic Order Ref.
-----------	---------------------	--------------------------------------	--------------------------------

Danger Highly flammable LPG

	300 x 250	701724	701723
-----------------------------------------------------------------------------------	-----------	--------	--------

Caution Highly flammable material

	150 x 125	701777	701778
	300 x 250	701779	701780

Danger Trip hazard

	150 x 125	701719	701720
	300 x 250	701722	701721

Danger Falling objects

	300 x 250	701675	701674
-------------------------------------------------------------------------------------	-----------	--------	--------

Caution Mind the step

	175 x 125	701682	701683
	300 x 250	701685	701684

Caution Wet floor

	300 x 250	701695	701694
-------------------------------------------------------------------------------------	-----------	--------	--------

Danger Fork lift trucks

	300 x 250	701697	701696
-------------------------------------------------------------------------------------	-----------	--------	--------

Pictogram	Size mm h x w	Self Adhesive Vinyl Order Ref.	Rigid Plastic Order Ref.
-----------	---------------------	--------------------------------------	--------------------------------

Danger Highly flammable

	150 x 125	701725	701726
-----------------------------------------------------------------------------------	-----------	--------	--------

Caution Fragile roof

	300 x 250	701690	701691
	600 x 450	701693	701692

Caution Overhead hazard

	300 x 250	701770	701769
------------------------------------------------------------------------------------	-----------	--------	--------

Danger Beware of step

	175 x 125	701698	701699
-------------------------------------------------------------------------------------	-----------	--------	--------

Danger Drop

	175 x 125	701679	701678
	300 x 250	701681	701680

Danger Slippery surface

	175 x 125	701687	701686
	300 x 250	701689	701688

Caution Fork lift trucks

	150 x 125	701781	701782
	300 x 250	701783	701784

Pictogram	Size mm h x w	Self Adhesive Vinyl Order Ref.	Rigid Plastic Order Ref.
-----------	---------------------	--------------------------------------	--------------------------------

Caution symbol



50 x 50	701673*	-
---------	---------	---

Danger



250 x 200	701752	701751
300 x 250	701750	701749

High temperature

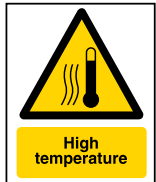

150 x 125	701801	701802
-----------	--------	--------

Electrical hazard symbol – all yellow



50 x 50	701737*	-
125 x 125	701738	701739

Main switch

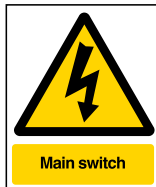

175 x 125	701700	701701
-----------	--------	--------

Caution High voltage

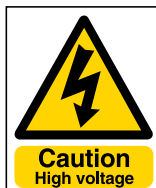

75 x 50	701758*	-
175 x 125	701759	701760
350 x 250	701761	701762

Caution Overhead cables



300 x 250	701787	701788
-----------	--------	--------

Caution 240 Volts



60 x 30	701768*	-
150 x 80	701767	-

Pictogram	Size mm h x w	Self Adhesive Vinyl Order Ref.	Rigid Plastic Order Ref.
-----------	---------------------	--------------------------------------	--------------------------------

Caution Reversing vehicles



300 x 250	701728	701727
-----------	--------	--------

Danger Very hot water



75 x 50	701803*	-
175 x 125	701804	701805

Electrical hazard symbol – white background

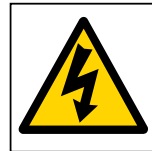

25 x 25	701713*	-
50 x 50	701712*	-
125 x 125	701714	701715

Caution Risk of electric shock



75 x 50	701753*	-
175 x 125	701754	701756
350 x 250	701755	701757

Caution Live busbars



150 x 125	701773	701774
300 x 250	701775	701776

Danger Mains voltage



50 x 50	701716*	-
---------	---------	---

Danger of death



300 x 250	701795	701796
-----------	--------	--------

Caution 415 Volts



60 x 30	701763*	-
150 x 80	701766	-
175 x 175	701765	701764

*10 signs per pack

Hazard Warning Signs

BRADY
Customize-it

See page 63 for information on
how to order a customized sign

Pictogram	Size mm h x w	Self Adhesive Vinyl Order Ref.	Rigid Plastic Order Ref.
-----------	---------------------	--------------------------------------	--------------------------------

Caution Non-ionising radiation

	75 x 50	701810*	–
	175 x 125	701811	701812

Caution Biological hazard

	150 x 125	701793	701794
--	-----------	--------	--------

Danger Moving machinery

	350 x 250	701730	701729
--	-----------	--------	--------

Danger Hot

	150 x 125	701734	701733
	300 x 250	701736	701735

Caution This machine runs hot

	50 x 125	701748	–
--	----------	--------	---

Caution Mind your head

	250 x 200	701771	701772
--	-----------	--------	--------

CCTV in operation

	250 x 200	–	802875
--	-----------	---	--------

Pictogram	Size mm h x w	Self Adhesive Vinyl Order Ref.	Rigid Plastic Order Ref.
-----------	---------------------	--------------------------------------	--------------------------------

Danger Laser hazard

	175 x 125	701717	701718
--	-----------	--------	--------

Radiation hazard symbol

	125 x 125	701702	701703
--	-----------	--------	--------

Hazardous area

	300 x 250	701677	701676
--	-----------	--------	--------

Danger Arc welding

	350 x 250	701732	701731
--	-----------	--------	--------

Danger Automatic machinery liable to start without warning

	175 x 125	701806	701807
	300 x 250	701808	701809

This car park is under 24 hour surveillance

	250 x 200	–	802876
--	-----------	---	--------

*10 signs per pack



Dangerous Substances and Explosive Atmospheres Regulations 2002 (DSEAR 2002)



Danger
Explosive atmosphere

There is some confusion over which symbol should be displayed in order to conform to DSEAR 2002. The symbol displayed in the DSEAR regulations is the EX symbol as shown on the left.

However, this symbol does not comply with current British Standards, and there is a possibility that DSEAR will be amended to align with British Standards. In order to promote best practice, and ensure full compliance with ISO 7010 and BS 5499 Part 5 2002, we advise you to use the symbol shown on the right.



Danger
Explosive atmosphere

Comply with the Dangerous Substances and Explosive Atmospheres Regulations 2002 (DSEAR 2002), which came fully into force on 30th June 2003.

- DSEAR 2002 concerns protection against risks from fire, explosion and similar events arising from dangerous substances used or present in the workplace and applies to all employers and the self-employed.
- Explosive substances can be found in varying quantities in most workplaces – substances such as paints, fuel, varnishes and solvents as well as the dust created from sand, grain or milling operations.
- If you use, create or store any explosive substances, you must mark all hazardous and storage areas with an explosive atmosphere safety symbol at each entry point.
- Multi-Message Signs are ideal for entrances to areas where you need to display an explosive atmosphere warning and another safety message.

Pictogram	Size mm h x w	Self Adhesive Vinyl Order Ref.	Rigid Plastic Order Ref.
-----------	---------------------	--------------------------------------	--------------------------------

Danger Explosive atmosphere



150 x 125	802928	802779
300 x 250	802778	802780

Pictogram	Size mm h x w	Self Adhesive Vinyl Order Ref.	Rigid Plastic Order Ref.
-----------	---------------------	--------------------------------------	--------------------------------

Danger Explosive atmosphere



150 x 125	802494	802495
300 x 250	802865	802866

Multi-Message – Danger Explosive atmosphere & No unauthorised access

300 x 450	802867	802868
-----------	--------	--------



Multi-Message – Explosive atmosphere & No smoking No naked lights

300 x 450	802869	802870
-----------	--------	--------



Multi-Message – Danger Explosive atmosphere & Before undertaking any work...

300 x 450	802871	802872
-----------	--------	--------



Multi-Message – Danger Explosive atmosphere & Keep locked shut when not in use

300 x 450	802873	802874
-----------	--------	--------





Prohibition Signs

Instruct staff and visitors when behaviour or action are prohibited

- The Health and Safety (Safety Signs and Signals) Regulations 1996 details that Prohibition Signs must be displayed to prohibit dangerous behaviour, access to certain areas and types of behaviour.
- Prohibition Signs must have a black pictogram encircled by a red band and then dissected by a red diagonal bar – the red must form 35% of the sign.
- Choose from 2 quality materials. Self-adhesive vinyl is a flexible material ideal for use on any smooth, indoor surface. Rigid plastic measures 1.5mm thick for extra durability (fixings required).
- Can't find the sign that suits your workplace? No problem! Simply call Brady Customer Service who will be happy to help.



In 2007 the Health Act 2006 will implement a workplace-smoking ban in England, Wales and Northern Ireland

The act lays down duties, requiring:

- Smoke free premises to display a no smoking sign;
- Any person in control of the management of smoke-free premises "to cause a person smoking there to stop smoking"; and
- All persons not to smoke on smoke free premises.



England
1st July 2007



Wales
2nd April 2007



Northern Ireland
30th April 2007



Scotland
26th March 2006

Pictogram	Size mm h x w	Self Adhesive Vinyl Order Ref.	Rigid Plastic Order Ref.
-----------	---------------------	--------------------------------------	--------------------------------

No smoking



75 x 50	701640*	–
175 x 125	701641	701642
360 x 250	701644	701643

Pictogram	Size mm h x w	Self Adhesive Vinyl Order Ref.	Rigid Plastic Order Ref.
-----------	---------------------	--------------------------------------	--------------------------------

Smoking strictly prohibited



300 x 250	701619	701620
-----------	--------	--------

Please do not smoke



300 x 250	701645	701646
-----------	--------	--------

No smoking beyond this point



250 x 200	701621	701622
-----------	--------	--------

No smoking Company policy



300 x 250	701556	701555
-----------	--------	--------

No smoking please



150 x 125	701623	701624
-----------	--------	--------

No smoking in this building



300 x 250	701560	701559
-----------	--------	--------

No smoking in the toilets



250 x 200	701557	701558
-----------	--------	--------

No smoking Hazardous area



300 x 250	701562	701561
-----------	--------	--------

You are entering a no smoking area



600 x 450	701564	701563
-----------	--------	--------

*10 signs per pack



Pictogram	Size mm h x w	Self Adhesive Vinyl Order Ref.	Rigid Plastic Order Ref.
-----------	------------------	-----------------------------------	-----------------------------

This is a no smoking zone

	300 x 250	701567	701566
This is a no smoking zone			

Please do not smoke

	50 x 150	-	701580
(Desk Sign – Rigid Plastic only)			

No smoking area

	50 x 250	701582	701581
No smoking area			

No smoking

	250 x 350	701571	701570
	450 x 600	701573	701572
No smoking			

Multi-message – No smoking No drinking or eating

	300 x 300	701569	701568
No smoking			
No drinking or eating			

No smoking, eating or drinking within this area

	250 x 200	701578	701579
No smoking, eating or drinking within this area			

No entry

	300 x 250	701588	701587
No entry			

Pictogram	Size mm h x w	Self Adhesive Vinyl Order Ref.	Rigid Plastic Order Ref.
-----------	------------------	-----------------------------------	-----------------------------

No smoking in this vehicle

	75 x 50	701565*	-
No smoking in this vehicle			

No smoking symbol

	50 x 50	701625*	-
	125 x 125	701627	701626
	250 x 250	701629	701628

Thank you for not smoking

	50 x 250	701615	701616
Thank you for not smoking			

Smoking prohibited in this area

	450 x 600	701575	701574
Smoking prohibited in this area			

Smoking and naked flames prohibited

	300 x 250	701659	701660
Smoking and naked flames prohibited			

Multi-message – No smoking No naked light

	250 x 350	701577	701576
No smoking			
No naked light			

No thoroughfare

	300 x 250	701590	701589
No thoroughfare			

*10 signs per pack

Prohibition Signs

BRADY
Customize-it

See page 63 for information on
how to order a customized sign

Pictogram	Size mm h x w	Self Adhesive Vinyl Order Ref.	Rigid Plastic Order Ref.
-----------	---------------------	--------------------------------------	--------------------------------

No admittance Authorized personnel only

	250 x 200	701594	701593
	300 x 250	701592	701591

Pictogram	Size mm h x w	Self Adhesive Vinyl Order Ref.	Rigid Plastic Order Ref.
-----------	---------------------	--------------------------------------	--------------------------------

No admittance

	300 x 250	701664	701663
-----------------------------------------------------------------------------------	-----------	--------	--------

Unauthorized persons prohibited beyond this point

	175 x 175	701636	701637
	300 x 250	701639	701638

No access

	300 x 250	701647	701648
-----------------------------------------------------------------------------------	-----------	--------	--------

No admittance without a permit to work

	175 x 125	701649	701650
	300 x 250	701651	701652

No access unless trained and authorised

	250 x 200	701584	701583
------------------------------------------------------------------------------------	-----------	--------	--------

No pedestrians

	300 x 250	701586	701585
-------------------------------------------------------------------------------------	-----------	--------	--------

No access for unauthorised persons

	250 x 200	701656	701655
	300 x 250	701653	701654

No entry

	300 x 250	701658	701657
-------------------------------------------------------------------------------------	-----------	--------	--------

No exit

	250 x 200	701630	701631
-------------------------------------------------------------------------------------	-----------	--------	--------

No unauthorised vehicles beyond this point

	450 x 600	701604	701603
-------------------------------------------------------------------------------------	-----------	--------	--------

No parking

	250 x 350	701665	701666
-------------------------------------------------------------------------------------	-----------	--------	--------



Pictogram	Size mm h x w	Self Adhesive Vinyl Order Ref.	Rigid Plastic Order Ref.
-----------	---------------	--------------------------------	--------------------------

Fork lift trucks prohibited



300 x 250 701668 701667

Fork lift trucks prohibited

Pictogram	Size mm h x w	Self Adhesive Vinyl Order Ref.	Rigid Plastic Order Ref.
-----------	---------------	--------------------------------	--------------------------

Unauthorised persons not to use this machine



250 x 200 701599 701600

Unauthorised persons not to use this machine

No unauthorised person to operate this machine

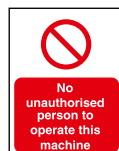

250 x 200 701634 701635

No unauthorised person to operate this machine

Do not use Out of order



250 x 200 701602 701601

Do not use Out of Order

In the event of fire do not use lifts



250 x 200 701606 701605

In the event of fire do not use lifts

It is strictly forbidden to climb on the racking



50 x 150 701608 701607

It is strictly forbidden to climb on the racking

Do not start Men working on machine



250 x 200 701618 701617

Do not start Men working on machine

Do not switch on. Men working on machine



100 x 250 701633 701632

Do not switch on. Men working on machine

No fouling



300 x 250 701662 701661

No fouling

No dogs except guide dogs



150 x 125 701610 701609

No dogs except guide dogs

Do not use mobile phones



250 x 200 701598 701597

Do not use mobile phones

Do not use mobile phones beyond this point



250 x 200 701612 701611

Do not use mobile phones beyond this point

Turn off all mobile phones



250 x 200 701614 701613

Turn off all mobile phones

Not drinking water



150 x 125 701596 701595

Not drinking water

Multi-Message Signs

Multi-Message Signs

Save money and wall space – instead of 2 or 3 signs you only need 1!

- Ideal for areas and situations where more than 1 safety message is required to warn employees, visitors or the public.
- Comply with the Health and Safety (Safety Signs and Signals) Regulations 1996.
- Choose from 2 quality materials. Self-adhesive vinyl is a flexible material ideal for use on any smooth, indoor surface. Rigid plastic measures 1.5mm thick for extra durability (fixings required).
- Can't find the sign that suits your workplace? No problem! Simply call Brady Customer Service who will be happy to help.



Pictogram	Size mm h x w	Self Adhesive Vinyl Order Ref.	Rigid Plastic Order Ref.
-----------	---------------------	--------------------------------------	--------------------------------

Multi-message – Warning Asbestos insulation, Do not disturb & Avoid damage

	100 x 200	701414	701415
--	-----------	--------	--------

Pictogram	Size mm h x w	Self Adhesive Vinyl Order Ref.	Rigid Plastic Order Ref.
-----------	---------------------	--------------------------------------	--------------------------------

Multi-message – Danger multi-hazard area & No admittance... & All visitors must...

	400 x 600	701393	701392
--	-----------	--------	--------

Multi-message – Danger & Keep out

	300 x 450	701397	701396
--	-----------	--------	--------

Multi-message – Danger Fragile roof & Use crawling boards

	400 x 600	701395	701394
--	-----------	--------	--------

Multi-message – Danger High voltage & Keep away

	300 x 450	701401	701400
--	-----------	--------	--------

Multi-message – Caution Dangerous site & Keep out

	400 x 600	701399	701398
--	-----------	--------	--------

Multi-message – Danger Deep water & Keep out

	300 x 450	701407	701406
--	-----------	--------	--------

Multi-message – Danger High voltage & Keep out

	300 x 450	701405	701404
--	-----------	--------	--------



All Brady Signs are available in your local language. Contact Brady Customer Service for more information

Multi-Message Signs

Pictogram	Size mm h x w	Self Adhesive Vinyl Order Ref.	Rigid Plastic Order Ref.
-----------	---------------------	--------------------------------------	--------------------------------

Multi-message – No smoking or naked flames & Highly flammable material
300 x 450 701377 701376



Pictogram	Size mm h x w	Self Adhesive Vinyl Order Ref.	Rigid Plastic Order Ref.
-----------	---------------------	--------------------------------------	--------------------------------

Multi-message – No smoking or naked flames & LPG Highly flammable
300 x 450 701379 701378



Multi-message – No smoking or naked flames & Petroleum spirit highly flammable
150 x 225 701380 701381
300 x 450 701383 701382



Multi-message – Do not operate & Caution Men working on this equipment
300 x 450 701385 701384



Multi-message – Do not cut or make any alteration & Caution Asbestos material
300 x 450 701386 701387



Multi-message – Danger Hazard area & Do not enter
300 x 450 701389 701388



Multi-message – Danger Risk of explosion & No smoking No naked lights
400 x 600 701391 701390



Multi-message – Danger High voltage & No unauthorised access
300 x 450 701403 701402



Multi-message – Danger & No unauthorised access
300 x 450 701409 701408



Multi-message – Dangerous Chemicals & No unauthorised access
300 x 450 701411 701410



Multi-message – Hazardous area & No unauthorised access
300 x 450 701413 701412



SAFETY SIGNS



Site Safety Notice

Display multiple messages – avoid multiple sign purchases

- Ensures compliance under the latest Health and Safety regulations.
- Highly-visible – leave no doubt as to the correct procedures on your site.
- Extremely durable – 800 x 600mm rigid 3mm foam PVC.
- Weatherproof and meets Class1 fire rated standards when tested to BS476 Part 7 1987 and UL94 rating V-0.
- Pre-drilled corner holes for easy mounting – supplied with 4 nylon ties for easy installation.

Pictogram	Size mm h x w	Rigid 3 mm Foam PVC Order Ref.
Site safety notice	600 x 800	701375



Construction Signs

Extra large signs can be erected quickly and easily

- Excellent for use where safety signs need to be read quickly and where a standard-sized safety sign could be easily overlooked.
- Place near entrances, power lines or large electrical installations.
- Corners are marked for drilling – use screws or nylon ties to hang.

Pictogram	Size mm h x w	3 mm Rigid Plastic Order Ref.
-----------	---------------	-------------------------------

Safety helmets must be worn in this area	800 x 600	702253
------------------------------------------	-----------	--------



Pictogram	Size mm h x w	3 mm Rigid Plastic Order Ref.
-----------	---------------	-------------------------------

Unauthorised persons prohibited beyond this point	800 x 600	702246
---------------------------------------------------	-----------	--------



High visibility clothing must be worn in this area	800 x 600	702255
----------------------------------------------------	-----------	--------



Multi-message – Danger construction site & Keep out	600 x 800	702258
-----------------------------------------------------	-----------	--------



Multi-message – No unauthorised access & All visitors must report to office & Safety helmets must be worn in this area & Protective footwear must be worn in this area	800 x 600	702257
------------------------------------------------------------------------------------------------------------------------------------------------------------------------	-----------	--------



Multi-message – You are entering a designated area & All persons must wear approved protective equipment as identified	600 x 800	702259
------------------------------------------------------------------------------------------------------------------------	-----------	--------





Harsh Environment Signs

Avoid accidents – Give clear, concise instructions

- Multiple messages help you ensure that adequate health and safety information is provided for all staff, customers and other members of the public.
- Comply with the Health and Safety (Safety Signs and Signals) Regulations 1996.
 - Noise Hazard Signs help you comply with the requirements of the Noise at Work Regulations 2005. Where noise levels exceed 85dB, ear protection is mandatory. Where noise levels are above 80dB, ear protection must be available on request.
 - Fire Hazard Signs conform to BS5378.
- Choose from 2 quality materials. Self-Adhesive Vinyl is a flexible material ideal for use on any smooth, indoor surface. Rigid Plastic measures 1.5mm thick for extra durability (fixings required).
- Can't find the sign that suits your workplace? No problem! Simply call Brady Customer Service who will be happy to help.



Pictogram	Size mm h x w	Self Adhesive Vinyl Order Ref.	Rigid Plastic Order Ref.
-----------	------------------	-----------------------------------	-----------------------------

Danger Noise level of 85dB (A) or above & Ear protectors must be worn



300 x 450	701552	701551
-----------	--------	--------

Pictogram	Size mm h x w	Self Adhesive Vinyl Order Ref.	Rigid Plastic Order Ref.
-----------	------------------	-----------------------------------	-----------------------------

Danger Noise hazard & Ear protectors must be worn



300 x 450	701554	701553
-----------	--------	--------

Danger Noise level between 80dB (A) and 85dB (A) & Ear protectors available on request



300 x 450	701550	701549
-----------	--------	--------

Noise hazard & Ear protectors available on request



300 x 450	701548	701547
-----------	--------	--------

Ear protection zone & No entry without ear protectors



300 x 450	701546	701545
-----------	--------	--------

Do not climb shelving & Use ladders provided



200 x 275	702290	702289
-----------	--------	--------

Petroleum mixture, No smoking & No naked lights



450 x 600	-	701669
-----------	---	--------

Highly flammable LPG, No smoking & No naked lights



450 x 600	-	701670
-----------	---	--------

Flammable vapour, No smoking & No naked lights



450 x 600	-	701671
-----------	---	--------

Highly flammable, No smoking & No naked lights



450 x 600	-	701672
-----------	---	--------

Photoluminescent Signs

BRADY
Customize-it

See page 63 for information on how to order a customized sign

Photoluminescent Signs

Will illuminate an escape route or important message when there is a power failure or when light sources are obscured by smoke.

- Visual communications compete with one another – in any emergency a photoluminescent safety message will stand out from other less important information.
- These signs provide 3-4 times the luminance performance when compared to P.S.P.A. Class A materials.
- They also include internationally recognised graphical symbols for escape routes, which comply with the requirements of the Health & Safety (Safety Signs & Signals) Regulations 1996 as recommended by the British Standard Document BS5499-4:2000.
- The signs ensure the correct use of a directional arrow within an escape route sign.
- They use upper and lower case lettering - visually impaired people read and understand words with an initial upper case more clearly.
- Rigid and Aluminium Fire Exit Signs can be used as single sided-hanging signs – simply drill two holes in the top border of the chosen sign.
- Fire Extinguisher Identification Signs contain graphical symbols from EN3-5: 1996, with instructions on which fires the extinguisher is safe to use and which it is not.



Fire Extinguisher Signs

Pictogram	Size mm h x w	Rigid Plastic Order Ref.
-----------	---------------------	-----------------------------

ABC powder	200 x 80	702046
------------	----------	--------



Pictogram	Size mm h x w	Rigid Plastic Order Ref.
-----------	---------------------	-----------------------------

Foam spray	200 x 80	702044
------------	----------	--------



Water	200 x 80	702042
-------	----------	--------



Carbon dioxide	200 x 80	702045
----------------	----------	--------



Fire hose reel	200 x 80	702043
----------------	----------	--------



Carbon dioxide	200 x 80	702262
----------------	----------	--------



BC powder	200 x 80	702263
-----------	----------	--------



Wet chemical	200 x 80	702264
--------------	----------	--------





All Brady Signs are available in your local language. Contact Brady Customer Service for more information

Photoluminescent Signs

Emergency Exit Signs

Pictogram	Size mm h x w	Self Adh. Vinyl Order Ref.	Rigid Plastic Order Ref.
Fire exit / running man right			
	120 x 340	702003	702002
	150 x 400	702001	702000
	200 x 450	702005	702004

Pictogram	Size mm h x w	Self Adh. Vinyl Order Ref.	Rigid Plastic Order Ref.
Fire exit / running man right / arrow right			
	120 x 340	702015	702014
	150 x 400	702013	702012
	200 x 450	702017	702016

Pictogram	Size mm h x w	Self Adh. Vinyl Order Ref.	Rigid Plastic Order Ref.
Arrow left / running man left / Fire exit			
	120 x 340	702009	702008
	150 x 400	702007	702006
	200 x 450	702011	702010

Pictogram	Size mm h x w	Self Adh. Vinyl Order Ref.	Rigid Plastic Order Ref.
Fire exit / running man right / arrow down			
	120 x 340	702027	702026
	150 x 400	702025	702024
	200 x 450	702029	702028

Pictogram	Size mm h x w	Self Adh. Vinyl Order Ref.	Rigid Plastic Order Ref.
Fire exit / running man right / arrow up			
	120 x 340	702021	702020
	150 x 400	702019	702018
	200 x 450	702023	702022

Pictogram	Size mm h x w	Self Adh. Vinyl Order Ref.	Rigid Plastic Order Ref.
Exit / running man right / arrow right			
	120 x 340	701991	701990
	150 x 400	701989	701988
	200 x 450	701993	701992

Pictogram	Size mm h x w	Self Adh. Vinyl Order Ref.	Rigid Plastic Order Ref.
Exit / running man right / arrow up			
	120 x 340	702033	702032
	150 x 400	702031	702030
	200 x 450	702035	702034

Pictogram	Size mm h x w	Self Adh. Vinyl Order Ref.	Rigid Plastic Order Ref.
Arrow left down / running man left / Exit			
	120 x 340	702270	702269
	150 x 400	702268	702267
	200 x 450	702266	702265

Pictogram	Size mm h x w	Self Adh. Vinyl Order Ref.	Rigid Plastic Order Ref.
Exit / running man right / arrow right down			
	120 x 340	702282	702281
	150 x 400	702280	702279
	200 x 450	702278	702277

Pictogram	Size mm h x w	Self Adh. Vinyl Order Ref.	Rigid Plastic Order Ref.
Exit / running man right			
	120 x 340	701985	701984
	150 x 400	701983	701982
	200 x 450	701987	701986

Pictogram	Size mm h x w	Self Adh. Vinyl Order Ref.	Rigid Plastic Order Ref.	
Stairwell signs				
	-2	150 x 150	803861	252446
		200 x 200	803863	803864
	-1	150 x 150	803865	803866
		200 x 200	803867	803868
	0	150 x 150	803869	803870
		200 x 200	803871	803872
	1	150 x 150	803873	803874
		200 x 200	803875	803876
	2	150 x 150	803877	803879
		200 x 200	803878	803880
	3	150 x 150	803881	803882
		200 x 200	803883	803884
	4	150 x 150	803885	803886
		200 x 200	803887	803888
	5	150 x 150	803889	803890
		200 x 200	803891	803892
	6	150 x 150	803893	803894
		200 x 200	803895	803896
	7	150 x 150	803897	803898
		200 x 200	803899	803900
8	150 x 150	803901	803902	
	200 x 200	803903	803904	
9	150 x 150	804040	804041	
	200 x 200	804042	804044	

Pictogram	Size mm h x w	Self Adh. Vinyl Order Ref.	Rigid Plastic Order Ref.
Arrow left / running man left / Exit			
	120 x 340	701997	701996
	150 x 400	701995	701994
	200 x 450	701999	701998

Pictogram	Size mm h x w	Self Adh. Vinyl Order Ref.	Rigid Plastic Order Ref.
Exit / running man right / arrow down			
	120 x 340	702039	702038
	150 x 400	702037	702036
	200 x 450	702041	702040

Pictogram	Size mm h x w	Self Adh. Vinyl Order Ref.	Rigid Plastic Order Ref.
Arrow left up / running man left / Exit			
	120 x 340	702276	702275
	150 x 400	702274	702273
	200 x 450	702272	702271

Pictogram	Size mm h x w	Self Adh. Vinyl Order Ref.	Rigid Plastic Order Ref.
Exit / man running right / arrow right up			
	120 x 340	702288	702287
	150 x 400	702286	702285
	200 x 450	702284	702283

SAFETY SIGNS

Wallcharts & Pocket Guides

EC Directives Wallcharts & Pocket Guides

Ensure your employees are aware of EC Safety Regulation requirements

- Provide instant information on all aspects of the recent EC Safety Regulations.
- Give staff a good, basic understanding of the regulations.
- Wallcharts are made from durable, rigid plastic. Pocket guides are made from semi-rigid plastic.

Chart / Guide	Size mm h x w	Semi-Rigid Plastic Order Ref.	Rigid Plastic Order Ref.	Chart / Guide	Size mm h x w	Semi-Rigid Plastic Order Ref.	Rigid Plastic Order Ref.
	The Manual Handling Operations Regulations 1992 – Wallchart 600 x 400	–	701973		The Health & Safety (Display Screen Equipment) Regulations 1992 – Wallchart 600 x 400	–	701979
	The Personal Protective Equipment at Work Regulations 1992 – Wallchart 600 x 400	–	701976		Provision and Use of Work Equipment Regulations 1998 – Wallchart 600 x 400	–	701980
	The Workplace Health, Safety and Welfare Regulations 1992 – Wallchart 600 x 400	–	701977		The Management of Health & Safety at Work Regulations 1999 – Wallchart 600 x 400	–	701978
	Manual Handling Training – Wallchart 600 x 400	–	701972		Display Screen Equipment Training – Wallchart 600 x 400	–	701975
	Manual Handling – Pack of 10 pocket guides 120 x 80	701974	–		Display Screen Equipment – Pack of 10 pocket guides 120 x 80	701981	–

Statutory & Information Notices

Made from encapsulated paper or rigid plastic to resist water, dirt and grime.

- It is an employer's duty to inform employees of all relevant regulations.
- The Provision & Use of Work Equipment Regulations 1998 Notice combines the following: Power Presses, Abrasive Wheels, Woodworking Machines and Horizontal Milling Machines.

Chart / Guide	Size mm h x w	Encapsulated Paper Order Ref.	Rigid Plastic Order Ref.
---------------	---------------------	-------------------------------------	--------------------------------

Provision & Use of work equipment regulations 1998 notice



615 x 415	701815	-
-----------	--------	---

Chart / Guide	Size mm h x w	Encapsulated Paper Order Ref.	Rigid Plastic Order Ref.
---------------	---------------------	-------------------------------------	--------------------------------

The electricity at work regulations 1989 notice



738 x 488	701813	-
-----------	--------	---

Safety tips for use on ladders

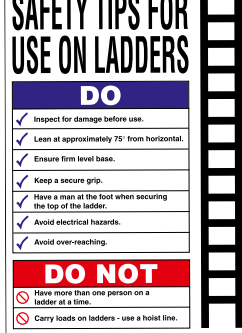

420 x 297	802929	-
-----------	--------	---

Treatment for asphyxia including electric shock notice



607 x 380	701814	-
-----------	--------	---

Health & Safety law notice



595 x 425	702228	-
-----------	--------	---

COSHH – Wallchart



600 x 400	-	702308
-----------	---	--------

COSHH – Pack of 10 pocket guides



120 x 80	-	702309
----------	---	--------

Safety Awareness Posters

Chart / Guide	Size mm h x w	Material	Order Reference
---------------	---------------------	----------	--------------------

Pipeline marking



600 x 400	1500 Micron Styrene	701827
-----------	---------------------	--------

Chart / Guide	Size mm h x w	Material	Order Reference
---------------	---------------------	----------	--------------------

6 Steps to fire safety



400 x 600	Rigid Plastic	701821
-----------	---------------	--------

Illegal drugs and you



600 x 400	1500 Micron Styrene	701823
-----------	---------------------	--------

Understanding safety signs



600 x 400	Semi-Rigid Plastic	701826
-----------	--------------------	--------

VDUs & You



330 x 785	Semi-Rigid Plastic	701822
-----------	--------------------	--------

5 Steps to risk assessment



600 x 400	Semi-Rigid Plastic	701824
-----------	--------------------	--------

Head to toe protection with PPE



485 x 330	Semi-Rigid Plastic	701825
-----------	--------------------	--------



Reflective Traffic & Works Safety Signs

Increase driver awareness on your site and surrounding approach roads

- Class 2 reflective material is ideal for private industrial estates, car parks and any site which has a need to control and direct vehicles or advise employees and visitors of potential hazards.
- Traffic symbols conform to BS873 – Part 6.
- Made from 3mm anodised aluminium plates with pressure-applied reflective faces
- UV-resistant faces will not fade or crack – ideal for external use and harsh environments.
- Fix on a wall or post with clamp.
- Signs without clamps are supplied undrilled.

Material: 3 mm anodised aluminium

BRADY
Customize-it

See page 63 for information on how to order a customized sign

Pictogram	Size mm	With clamps Order Ref.	Without clamps Order Ref.
-----------	---------	------------------------	---------------------------

Stop

600

701950

701971



Pictogram	Size mm	With clamps Order Ref.	Without clamps Order Ref.
-----------	---------	------------------------	---------------------------

Give way

600

701921

701951



Pictogram	Size mm	With clamps Order Ref.	Without clamps Order Ref.
-----------	---------	------------------------	---------------------------

No entry

600

701926

701952



Pictogram	Size mm	With clamps Order Ref.	Without clamps Order Ref.
-----------	---------	------------------------	---------------------------

5 miles per hour speed limit

600

701933

701957



750

701932

–

Pictogram	Size mm	With clamps Order Ref.	Without clamps Order Ref.
-----------	---------	------------------------	---------------------------

10 miles per hour speed limit

600

701935

701958



750

701934

–

Pictogram	Size mm	With clamps Order Ref.	Without clamps Order Ref.
-----------	---------	------------------------	---------------------------

15 miles per hour speed limit

600

701936

701959



Pictogram	Size mm	With clamps Order Ref.	Without clamps Order Ref.
-----------	---------	------------------------	---------------------------

No left turn

600

702247

702245



Pictogram	Size mm	With clamps Order Ref.	Without clamps Order Ref.
-----------	---------	------------------------	---------------------------

No right turn

600

701937

702248



Pictogram	Size mm	With clamps Order Ref.	Without clamps Order Ref.
-----------	---------	------------------------	---------------------------

Give way to oncoming traffic

600

701946

–



Pictogram	Size mm	With clamps Order Ref.	Without clamps Order Ref.
-----------	---------	------------------------	---------------------------

Height restriction

600

–

701960

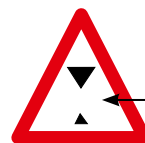

Specify the height restriction when ordering

Reflective Traffic & Works Safety Signs

Pictogram	Size mm h x w	With clamps Order Ref.	Without clamps Order Ref.
-----------	---------------------	------------------------------	---------------------------------

Two way traffic ahead	600	701939	-
-----------------------	-----	--------	---



Uneven road surface	600	701949	-
	750	701948	-



Black/yellow diagonal hazard	200 x 1000	701919	-
------------------------------	------------	--------	---



Height restriction	200 x 1000	701922	-
--------------------	------------	--------	---



Specify the height restriction when ordering

Pictogram	Size mm h x w	With clamps Order Ref.	Without clamps Order Ref.
-----------	---------------------	------------------------------	---------------------------------

Pedestrians crossing	600	701940	701961
----------------------	-----	--------	--------



Priority left lane traffic	675 x 600	701947	-
----------------------------	-----------	--------	---



Red/white diagonal hazard	200 x 1000	701920	-
---------------------------	------------	--------	---



All Brady Signs are available in your local language. Contact Brady Customer Service for more information

In	450 x 600	802931	802932
----	-----------	--------	--------



Out	450 x 600	701929	701955
-----	-----------	--------	--------



Arrow right one way	450 x 600	701928	701954
---------------------	-----------	--------	--------



Arrow left one way	450 x 600	701927	701953
--------------------	-----------	--------	--------



No exit	450 x 600	701930	-
---------	-----------	--------	---



No entry	450 x 600	701931	701956
----------	-----------	--------	--------





No parking in front of these gates	450 x 600	-	701962
------------------------------------	-----------	---	--------





No parking in this area	450 x 600	-	701953
-------------------------	-----------	---	--------





Pictogram	Size mm h x w	With clamps Order Ref.	Without clamps Order Ref.
Slow			
	450 x 600	701941	701964

Pictogram	Size mm h x w	With clamps Order Ref.	Without clamps Order Ref.
No unauthorised vehicles allowed beyond this point			
	450 x 600	–	701965

Pictogram	Size mm h x w	With clamps Order Ref.	Without clamps Order Ref.
Disabled badge holders only			
	200 x 300	701918	–

Pictogram	Size mm h x w	With clamps Order Ref.	Without clamps Order Ref.
Warning Unauthorised vehicles will be clamped			
	450 x 600	701943	701967

Pictogram	Size mm h x w	With clamps Order Ref.	Without clamps Order Ref.
Warning CCTV security in operation on these premises			
	450 x 600	701945	701970

Pictogram	Size mm h x w	With clamps Order Ref.	Without clamps Order Ref.
Warning Private Parking Wheel Clamping in Operation			
	450 x 600	701923	–

Pictogram	Size mm h x w	With clamps Order Ref.	Without clamps Order Ref.
Warning No Parking Vehicles Will Be Clamped			
	450 x 600	701924	–

Pictogram	Size mm h x w	With clamps Order Ref.	Without clamps Order Ref.
Security notice Closed circuit T.V. surveillance in operation			
	500 x 500	701925	–

Pictogram	Size mm h x w	With clamps Order Ref.	Without clamps Order Ref.
Goods inwards / arrow left			
	450 x 600	–	701968

Pictogram	Size mm h x w	With clamps Order Ref.	Without clamps Order Ref.
Notice Vehicles and contents are left here entirely at owners risk			
	450 x 600	701942	701966

Pictogram	Size mm h x w	With clamps Order Ref.	Without clamps Order Ref.
Fire assembly point			
	450 x 600	701944	701969



Traffic Sign Posts

Made from high-tensile steel.

- U-channel posts have 9.5 mm diameter holes spaced every 25 mm along the centre.
- Galvanised posts are rustproof and resist abrasion. Green backed enamel posts have a more durable, attractive finish.
- When determining the length of post required, please note that at least 305 mm must be underground for 1.2 m posts while 457 mm must be underground for 1.8 m+ posts.

Enamel posts	Height	Order Ref.
	1.2 m	702249
	1.8 m	702250
	2.1 m	702251
	2.4 m	702252
Galvanised posts	Height	Order Ref.
	1.8 m	702254
	2.4 m	702256

Vandal Resistant Traffic & Property Signs



Vandal Resistant Traffic & Property Signs

Exceptionally tough material is suited to use in areas where vandalism can be a problem

- Made from 3 mm rigid anodised aluminium, heat treated with a special compound to seal and protect the sign's integrity
- Easily cleaned if subjected to graffiti
- Rigidity and durability surpasses both plastic and polycarbonate materials
- Resists attack from heat and weathering
- Supplied with holes for easy fixing

Pictogram	Size mm h x w	Order Reference
-----------	---------------	-----------------

5 miles per hour speed limit



300	701857
600	701858

Pictogram	Size mm h x w	Order Reference
-----------	---------------	-----------------

10 miles per hour speed limit



300	701865
600	701866

15 miles per hour speed limit



300	701885
600	701886

Stop



300	701901
600	701902

Give way



600	701907
750	701908

No entry



300	701909
600	701910

Slow



300 x 400	701911
450 x 600	701912

Caution Speed ramps



300 x 400	701913
450 x 600	701914

No unauthorised vehicles allowed beyond this point

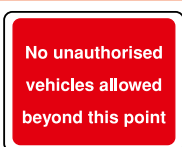

300 x 400	701915
450 x 600	701916

No parking



300 x 400	701859
450 x 600	701860



All Brady Signs are available in your local language. Contact Brady Customer Service for more information

Vandal Resistant Traffic & Property Signs

Pictogram	Size mm h x w	Order Reference
-----------	---------------------	-----------------

This area must be kept clear for emergency vehicles



300 x 400	701861
450 x 600	701862

In



300 x 400	701867
450 x 600	701868

Arrow right one way



300 x 400	701863
450 x 600	701864

No entry



300 x 400	701871
450 x 600	701872

Private property keep out



300 x 400	701875
450 x 600	701876

Visitors car park



300 x 400	701879
450 x 600	701880

Reserved Parking



300 x 400	701883
450 x 600	701884

Disabled badge holders only



300 x 400	701889
450 x 600	701890

Warning CCTV cameras in operation on these premises

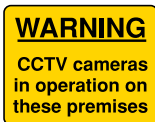

300 x 400	701891
450 x 600	701892

Warning Private Parking Wheel Clamping in operation



300 x 400	701895
450 x 600	701896

No Ball Games



300 x 400	701899
450 x 600	701900

Pictogram	Size mm h x w	Order Reference
-----------	---------------------	-----------------

Private Road Authorised Vehicles Only



300 x 400	701903
450 x 600	701904

Out



300 x 400	802933
450 x 600	802934

Arrow left one way



300 x 400	701873
450 x 600	701874

No exit



300 x 400	701869
450 x 600	701870

Private property trespassers will be prosecuted

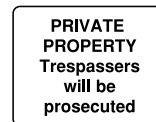

300 x 400	701877
450 x 600	701878

Private car park

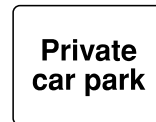

300 x 400	701881
450 x 600	701882

Notice Vehicles and contents are left here entirely at owners risk



300 x 400	701887
450 x 600	701888

Please do not park in front of these gates

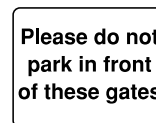

300 x 400	701905
450 x 600	701906

Warning Unauthorised vehicles will be clamped



300 x 400	701893
450 x 600	701894

Warning No Parking Vehicles Will Be Clamped



300 x 400	701897
450 x 600	701898



Designed to warn for hazardous areas, putting valuable safety information directly at the point of need. These floor signs are manufactured from polyester, with a clear, matt anti-slip laminate to prevent falling accidents while protecting the graphics underneath. The tough Brady adhesive can be applied to most clean, dry, smooth floors.



Sign Sizes	
Round signs	Diameter 500 mm
Triangular signs	Side 500 mm
Square signs	Side 500 mm
Rectangular signs	400 x 200 mm

Emergency Escape & Fire Equipment Signs

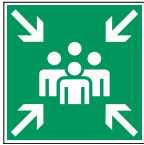

Order Ref. 223637



800004



800005



800006

Mandatory Signs



Order Ref. 800007



800008



800009



800002



223648



800003



223665

Prohibition Signs



Order Ref. 800010



223651



800011



800018



223654



800012



800013

Traffic Signs



Order Ref. 223657



223658

Warning Signs



Order Ref. 800014



800015



223659



Order Ref. 223664



800016



800017





Conform with current UK and European Legislation including the Draft International Standard DIS 3864 Part 1, which requires a white border for Safe Condition and Fire Exit Signs.

Choose from 2 quality materials:



Self-adhesive vinyl

Lightweight, flexible material is ideal for use in offices, light industrial factories, warehouses, standard indoor and dry outdoor environments when applied to a clean, dry, smooth surface. Simply peel off the backing paper and apply.



Rigid plastic

Firm, rigid material is pre-drilled with 4 mounting holes. Requires fixings. Has some resistance to certain chemicals. Use in offices, light industrial factories, warehouses, standard indoor environments and clean rooms.

Pictogram	Size mm w x h	Self Adhesive Vinyl Order Ref.	Rigid Plastic Order Ref.
-----------	---------------	--------------------------------	--------------------------

Danger Electric shock risk

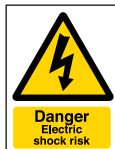

A4 (210 x 297)	701342	701341
----------------	--------	--------

Danger Slippery surface



A4 (210 x 297)	701346	701345
----------------	--------	--------

Caution Biological hazard



A4 (210 x 297)	701350	701349
----------------	--------	--------

Running man right / arrow right / Fire exit



A4 (210 x 297)	701304	701303
----------------	--------	--------

Running man right / arrow down / Fire exit



A4 (210 x 297)	701308	701307
----------------	--------	--------

Arrow left / running man left / Fire exit



A4 (210 x 297)	701306	701305
----------------	--------	--------

No entry



A3 (297 x 420)	701286	701285
A4 (210 x 297)	701334	701333

No access for unauthorised persons



A4 (210 x 297)	701340	701339
----------------	--------	--------

Pictogram	Size mm w x h	Self Adhesive Vinyl Order Ref.	Rigid Plastic Order Ref.
-----------	---------------	--------------------------------	--------------------------

Danger Fork lift trucks



A3 (297 x 420)	701292	701291
A4 (210 x 297)	701344	701343

Caution Mind the step



A4 (210 x 297)	701348	701347
----------------	--------	--------

Caution Fragile roof



A3 (297 x 420)	701294	701293
A4 (210 x 297)	701352	701351

First Aid



A4 (210 x 297)	701302	701301
A5 (148 x 210)	701360	701359

Fire assembly point



A3 (297 x 420)	701278	701277
A4 (210 x 297)	701300	701299

No admittance Authorised personnel only



A3 (297 x 420)	701288	701287
A4 (210 x 297)	701336	701335
A5 (148 x 210)	701374	701373

Unauthorised persons prohibited beyond this point



A3 (297 x 420)	701290	701289
A4 (210 x 297)	701338	701337

Smoking strictly prohibited



A4 (210 x 297)	701332	701331
----------------	--------	--------

A3, A4 & A5 Signs

BRADY
Customize-it

See page 63 for information on
how to order a customized sign

Pictogram	Size mm w x h	Self Adhesive Vinyl Order Ref.	Rigid Plastic Order Ref.
-----------	---------------------	--------------------------------------	--------------------------------

No smoking



A3 (297 x 420)	701284	701283
A4 (210 x 297)	701328	701327
A5 (148 x 210)	701372	701371

Fire Wardens



A4 (210 x 297)	701330	701329
----------------	--------	--------

Fire Alarm Call Point



A5 (148 x 210)	701364	701363
----------------	--------	--------

Fire extinguisher containing powder

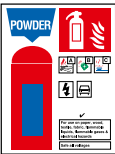

A4 (210 x 297)	702232	702231
A5 (148 x 210)	701354	701353

Fire extinguisher containing foam



A4 (210 x 297)	702234	702233
A5 (148 x 210)	702236	702235

Eye protection must be worn



A3 (297 x 420)	701280	701279
A4 (210 x 297)	701316	701315
A5 (148 x 210)	701368	701367

Hearing protection must be worn



A4 (210 x 297)	701320	701319
A5 (148 x 210)	701370	701369

Foot protection must be worn



A4 (210 x 297)	701324	701323
----------------	--------	--------

All visitors must report to reception



A3 (297 x 420)	701282	701281
----------------	--------	--------

Pictogram	Size mm w x h	Self Adhesive Vinyl Order Ref.	Rigid Plastic Order Ref.
-----------	---------------------	--------------------------------------	--------------------------------

No smoking company policy



A4 (210 x 297)	701326	701325
----------------	--------	--------

Fire extinguisher



A4 (210 x 297)	701310	701309
A5 (148 x 210)	701362	701361

Fire extinguisher containing water



A4 (210 x 297)	701312	701311
A5 (148 x 210)	701366	701365

Fire extinguisher containing CO₂

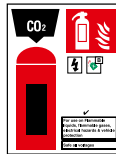

A4 (210 x 297)	701298	701297
A5 (148 x 210)	701356	701355

Hand protection must be worn



A4 (210 x 297)	701318	701317
----------------	--------	--------

Head protection must be worn



A4 (210 x 297)	701322	701321
----------------	--------	--------

Fire action



A4 (210 x 297)	701296	701295
A5 (148 x 210)	701358	701357

Keep clear



A4 (210 x 297)	701314	701313
----------------	--------	--------

4 types available:

1



Self-adhesive signs in laminated polyester – PE

These signs are printed using thermal transfer technology and protected by a clear polyester laminate. Backed with an acrylic based, pressure sensitive adhesive, giving excellent adhesion to low surface energy surfaces.

2



Rigid signs in polypropylene – PP

These signs are printed using thermal transfer technology and protected by a clear polyester and are backed with a rigid polypropylene material with a thickness of 1.5 mm.

3



Double-sided signs in rigid polypropylene – DF

Highly visible double-sided hanging safety signs make sure your safety message can be seen from all sides. These signs grab employees' attention and help communicate the importance of safety effectively. Ideal to complement the standard range. Made of polyester stuck on rigid polypropylene. Pre-drilled holes for easy installation.

4



Rigid polypropylene signs – self-adhesive back – SA

The ideal solution when you may not perforate the supporting surface (furniture, partition wall, etc.) or when you need to apply the sign quickly.

The pictograms illustrate the text and guarantee that its message is understood by visitors, temporary staff, maintenance crews etc.

**BRADY
Customize-it**

On the next page you can see our standard range of safety signs in the sizes A5/A4/A3/A2/A1.

For more information on personalized signs, see our "customize-it" service on page 63



Sizes:
A5: 148 mm x 210 mm
A4: 210 mm x 297 mm
A3: 297 mm x 420 mm
A2: 420 mm x 594 mm
A1: 594 mm x 840 mm

Safety Signs A5/A4/A3/A2/A1 – Standard Range



How to order a sign from this standard range?

The references for these signs all follow the same 3-part format:

1. The PIC number
2. The size
3. The material (PE, PP, DF, SA)

























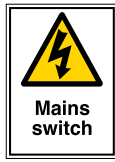







PIC200EA5PE

The PIC number in this case is PIC200E

The size in this case is A5

The material in this case is laminated polyester

 No smoking PIC 200 E	 No naked light PIC 201 E	 No access for unauthorized persons PIC 209 E	 No entrance PIC 229 E	 No mobile phones PIC 235 E	 No pedestrian access PIC 202 E	 Not drinking water PIC 204 E	 No parking PIC 227 E	 Wear eye protection PIC 250 E
 Wear head protection PIC 251 E	 Wear ear protection PIC 252 E	 Wear foot protection PIC 254 E	 Wear hand protection PIC 255 E	 Wear safety harness PIC 273 E	 Pedestrians must use this route PIC 256 E	 This way only PIC 258 E	 Wear protective clothing PIC 260 E	 Wear face shield PIC 265 E
 Wear mask PIC 267 E	 Danger Highly Flammable PIC 300 E	 Caution Corrosive substance PIC 303 E	 Mains switch PIC 307 E	 Caution PIC 308 E	 Hot surface PIC 315 E	 Danger Overhead crane PIC 305 E	 Danger Forklift trucks PIC 306 E	 Caution Non-ionising radiation PIC 311 E
 Harmful chemicals PIC 321 E	 Danger Slippery surface PIC 324 E	 Caution Mind the step PIC 325 E	 Caution Electrostatic danger PIC 327 E	 Caution Moving parts PIC 334 E	 First aid PIC 352 E	 Eye wash PIC 354 E	 Emergency stretcher PIC 355 E	 Emergency shower PIC 356 E
 Assembly point PIC 377 E	 Fire ladder PIC 400 E	 Fire hose reel PIC 401 E	 Fire alarm phone PIC 402 E	 Fire extinguisher PIC 403 E	 Fire alarm point PIC 412 E	 Fire fighting material PIC 407 E	 All Brady Signs are available in your local language. Contact Brady Customer Service for more information	

Safety Signs on Rolls – Laminated Polyester



Material: laminated polyester
Number of signs per roll: 250
Available sizes:

- Triangular signs with a side of 25, 50 or 100 mm
- Round signs with a diameter of 25, 50 or 100 mm

BRADY
Customize-it

Other sizes and signs are available on request.

Warning Signs

Order Ref.	PIC 300	PIC 301	PIC 302	PIC 303	PIC 304	PIC 305	PIC 307	PIC 308	PIC 309	PIC 310	
Size (mm)	Δ 25	227325	227326	227327	800100	251955	227329	251951	251950	251957	227331
	Δ 50	227353	227354	227355	800101	223315	227357	223307	223305	223319	227359
	Δ 100	227300	227301	227302	800102	223316	227304	223308	223306	223320	227306
Order Ref.	PIC 311	PIC 312	PIC 313	PIC 314	PIC 315	PIC 316	PIC 320	PIC 321	PIC 322	PIC 324	
Size (mm)	Δ 25	227332	227333	227334	227335	251956	227336	251952	227339	227340	227342
	Δ 50	227360	227361	227362	227363	223317	227364	223309	227367	227368	227370
	Δ 100	227307	227308	227309	227310	223318	227311	223310	227314	227315	227317
Order Ref.	PIC 327	PIC 329	PIC 334	PIC 336	PIC 337	PIC 349					
Size (mm)	Δ 25	251954	251953	223339	227348	227349	227350				
	Δ 50	223313	223311	223340	227375	227276	227274				
	Δ 100	223314	223312	223341	227322	227277	227275				

Regulatory Signs



Order Ref.	PIC 467
Size (mm)	Ø 25 251965
	Ø 50 223333
	Ø 100 223334

Mandatory Signs

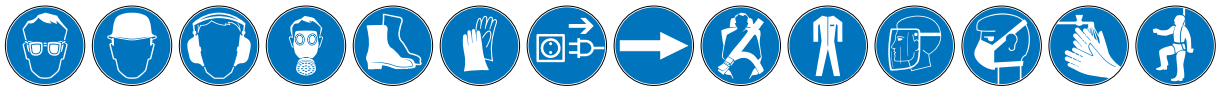

Order Ref.	PIC 250	PIC 251	PIC 252	PIC 253	PIC 254	PIC 255	PIC 257	PIC 258	PIC 259	PIC 260	PIC 265	PIC 267	PIC 271	PIC 273
Size (mm)	Ø 25	251961	251962	251963	227496	227497	227498	227500	227501	227502	227503	227508	227510	227514
	Ø 50	223327	223329	223331	227524	227525	227526	227528	227529	227530	227531	227536	227538	227541
	Ø 100	223328	223330	223332	227468	227469	227470	227472	227473	227474	227475	227480	227482	227485

Prohibition Signs



Order Ref.	PIC 200	PIC 201	PIC 204	PIC 205	PIC 209	PIC 212	PIC 216	PIC 218	PIC 224	PIC 235	
Size (mm)	Ø 25	251958	251959	227410	227411	251960	227417	227421	227423	227429	227437
	Ø 50	223321	223323	227440	227441	223325	227447	227451	227453	227459	227467
	Ø 100	223322	223324	227380	227381	223326	227387	227391	227393	227399	227407

Traffic Signs



Order Ref.	PIC 229	PIC 230	
Size (mm)	Ø 25	223345	227434
	Ø 50	223346	227464
	Ø 100	223347	227404

Safety Signs on Rolls – Vinyl

Pictogram	Size mm h x w	Labels per Roll	Self Adhesive Vinyl Order Ref.
-----------	------------------	-----------------	--------------------------------

No smoking symbol	50 x 50	500	701836

Electrical hazard symbol	25 x 25 50 x 50	1000 500	701829 701834

Dangerous chemicals symbol	25 x 25	1000	701846

Laser hazard symbol	25 x 25	1000	701830

General hazard symbol	25 x 25 50 x 50	1000 500	701833 701835

Danger Asbestos	25 x 25 50 x 50	1000 500	701837 701854

Pictogram	Size mm h x w	Labels per Roll	Self Adhesive Vinyl Order Ref.
-----------	------------------	-----------------	--------------------------------

Flammable symbol	25 x 25 50 x 50	1000 500	701848 701832

Corrosive, caustic, acid symbol	25 x 25 50 x 50	1000 500	701849 701853

Radiation risk symbol	25 x 25 50 x 50	1000 500	701851 701845

Biological hazard symbol	50 x 50	1000	701856

Chemical irritants symbol	25 x 25	1000	701847

Danger 230V	50 x 25	500	701842

Wear eye protection symbol	25 x 25	1000	701838

Wear hearing protection symbol	25 x 25 50 x 50	1000 500	701840 701850

Warning contains asbestos	50 x 25	500	701831

Blank Corridor and Projecting Signs

Make your own projecting or corridor signs. By using the blank signs together with one of our standard symbols you can add improved visibility to the signs of your choice. Both types offer a major improvement in visibility and have pre-drilled holes for easy installation.

H x W (mm)	287134	253544
151 x 151	287119	253545
203 x 203	223990	223992
203 x 403	287128	253546
253 x 253	222582	222583
318 x 318	287126	222586
151 x 300	225184	225185
213 x 300	287133	222587
300 x 151	223991	223993
403 x 203	222584	222585
603 x 203		



In the event of an emergency it is vital that persons are evacuated safely and as quick as possible. This range of mini-pictograms is specifically designed to be put on your emergency plans.



Mini-pictogram booklet

- Containing 10 sheets: a collection of 150 signs, numbers and letters.
- Size of signs: 10 x 10 mm or 10 x 20 mm.
- Size of numbers and letters: 5 x 5 mm.

Material: Transparent vinyl film with permanent adhesive.

Order Ref.	Description
286903	Mini-pictogram booklet

The sheets in this booklet (mini-1 to mini-10) are also available separately, as displayed below.

Mini-pictogram sheets

- 1 sheet per pack

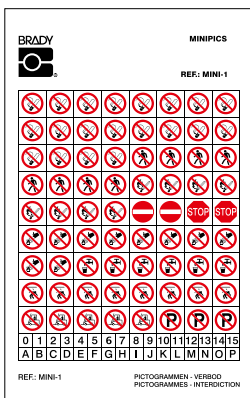

Mini 1:
Prohibition
286904

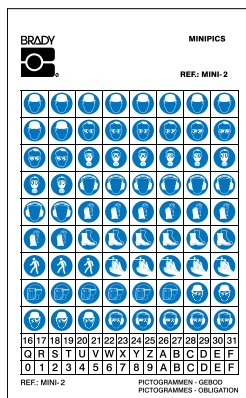

Mini 2:
Mandatory
286905

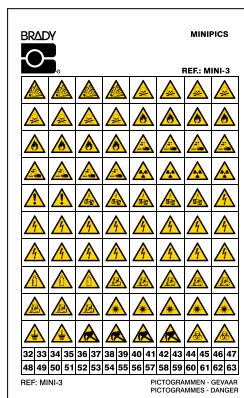

Mini 3:
Danger
286906

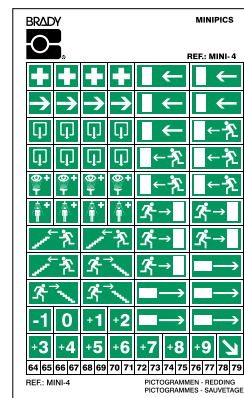

Mini 4:
First Aid/Emergency escape
286916

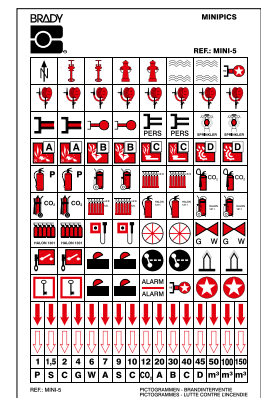

Mini 5:
Fire equipment
286917

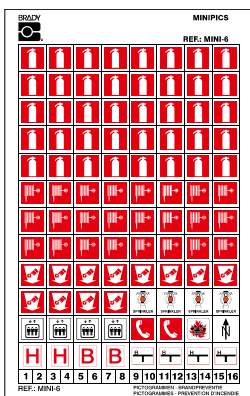

Mini 6:
Fire equipment
286909

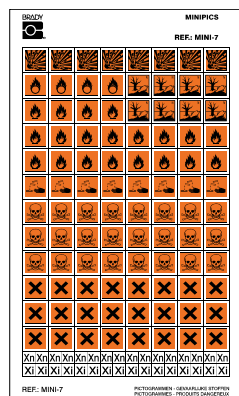

Mini 7:
Dangerous products
286910

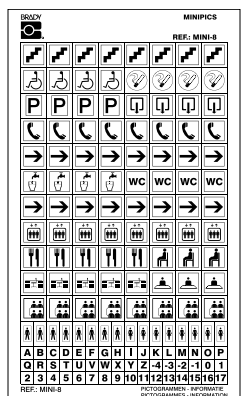

Mini 8:
Information
286911

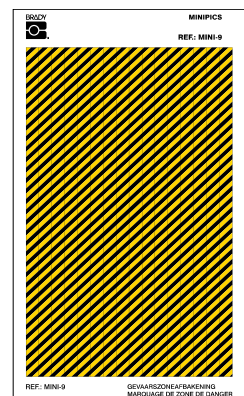

Mini 9:
Danger zones
286912

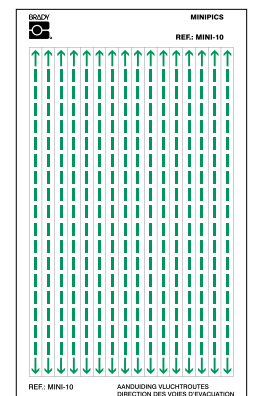

Mini 10:
Emergency escape routes
286913

Transport Signs

Hazard Warning Diamond Placards

- This product enables you to fill in the UN number of the dangerous substances being carried.
- Material: Self-adhesive laminated polyester
- **Size:** 300 x 300 mm

BRADY
Customize-it

These placards can be pre-printed with a UN number on request. Contact your BRADY distributor for more information.



Pictogram	HWDP1	HWDP2	HWDP3	HWDP4	HWDP5
Order Ref.	258885	258886	258887	258888	258889



Pictogram	HWDP8	HWDP9	HWDP10	HWDP11	HWDP12
Order Ref.	258892	258893	258894	258895	258896

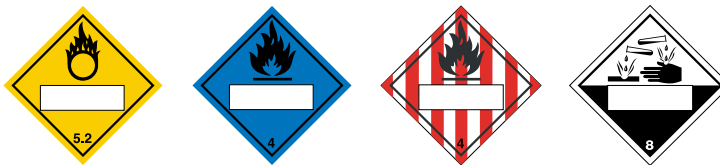

Pictogram	HWDP6	HWDP7	HWDP13	HWDP14
Order Ref.	258890	258891	258897	258898

SAFETY SIGNS

Removable Vinyl Numbering Kit

- Use with placards to indicate 4-digit DOT contents designation
- Made of vinyl with removable adhesive
- Character height: 90 mm
- Characters are black
- Each kit contains 1200 numbers as follows:
 - 200 x 0
 - 200 x 1
 - 100 x numbers 2 to 9

Order Ref.	Description
030659	Removable vinyl numbering kit

On-the-spot content marking is a snap with this convenient Numbering Kit.

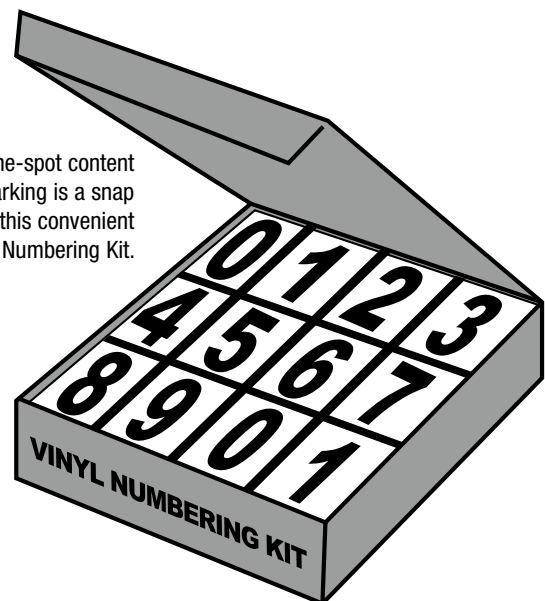

Pictogram	Size side (mm)	B-7541 Polyester Self-adh. Order Ref.	B-7541 Roll (250/roll) Order Ref.	B-859 Magnetic material Order Ref.	B-7525 Aluminium plate Order Ref.
-----------	----------------	---------------------------------------	-----------------------------------	------------------------------------	-----------------------------------

Explosive					
ADR 1	100	223549	223589		
	200	223550			
	297	223551		223587	223588



Explosive					
ADR 1.5	100	223555	223595		
	200	223556			
	297	223557		223593	223594



Flammable gas					
ADR 2.1a	100	227587	227590		
	200	227588			
	297	227589		227591	227592



Non-flammable, non toxic gas					
ADR 2.2b	100	257502	223574		
	200	257503			
	297	257573		258943	258944

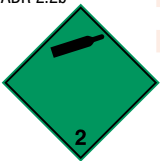

Toxic gas					
ADR 2.3	100	227791	227794		
	200	227792			
	297	227793		227795	227796



Flammable liquid					
ADR 3b	100	223564	223604		
	200	223565			
	297	223566		223602	223603



Spontaneous ignition					
ADR 4.2	100	257508	223577		
	200	257509			
	297	257576		258952	258953



Pictogram	Size side (mm)	B-7541 Polyester Self-adh. Order Ref.	B-7541 Roll (250/roll) Order Ref.	B-859 Magnetic material Order Ref.	B-7525 Aluminium plate Order Ref.
-----------	----------------	---------------------------------------	-----------------------------------	------------------------------------	-----------------------------------

Explosive					
ADR 1.4	100	223552	223592		
	200	223553			
	297	223554		223590	223591



Explosive					
ADR 1.6	100	223558	223598		
	200	223559			
	297	223560		223596	223597



Flammable gas					
ADR 2.1b	100	227593	227596		
	200	227594			
	297	227595		227597	227598



Non-flammable, non-toxic gas					
ADR 2.2a	100	223561	223601		
	200	223562			
	297	223563		223599	223600



Highly flammable liquid					
ADR 3a	100	257504	223575		
	200	257505			
	297	257574		258946	258947



Flammable solid					
ADR 4.1	100	257506	223576		
	200	257507			
	297	257575		258949	258950



Flammable when wet					
ADR 4.3	100	257510	223578		
	200	257511			
	297	257577		258955	258956



Transport Signs

Pictogram	Size side (mm)	B-7541 Polyester Self-adh. Order Ref.	B-7541 Roll (250/roll) Order Ref.	B-859 Magnetic material Order Ref.	B-7525 Aluminium plate Order Ref.
-----------	----------------	---------------------------------------	-----------------------------------	------------------------------------	-----------------------------------

Flammable when wet

ADR 4.3b	100	223567	223607		
	200	223568			
	297	223569		223605	223606



Organic peroxide

ADR 5.2	100	810934	810935		
	200 <td>810936 <td></td> <td></td> <td></td> </td>	810936 <td></td> <td></td> <td></td>			
	297 <td>810937 <td></td> <td>810938</td> <td>810939</td> </td>	810937 <td></td> <td>810938</td> <td>810939</td>		810938	810939



Infectious substance

ADR 6.2	100	257534	223583		
	200 <td>257535 <td></td> <td></td> <td></td> </td>	257535 <td></td> <td></td> <td></td>			
	297 <td>257536 <td></td> <td>258970</td> <td>258971</td> </td>	257536 <td></td> <td>258970</td> <td>258971</td>		258970	258971



Radioactive 7B II

ADR 7B	100	811666	811667		
	200 <td>811668 <td></td> <td></td> <td></td> </td>	811668 <td></td> <td></td> <td></td>			
	297 <td>811669 <td></td> <td>811670</td> <td>811671</td> </td>	811669 <td></td> <td>811670</td> <td>811671</td>		811670	811671



Radioactive 7D

ADR 7	100	257522	223610		
	200 <td>257523 <td></td> <td></td> <td></td> </td>	257523 <td></td> <td></td> <td></td>			
	297 <td>257583 <td></td> <td>223608</td> <td>223609</td> </td>	257583 <td></td> <td>223608</td> <td>223609</td>		223608	223609



Corrosive substance

ADR 8	100	257524	223585		
	200 <td>257525 <td></td> <td></td> <td></td> </td>	257525 <td></td> <td></td> <td></td>			
	297 <td>257584 <td></td> <td>258976</td> <td>258977</td> </td>	257584 <td></td> <td>258976</td> <td>258977</td>		258976	258977



Dangerous substance for the Environment

ADR 9	100	813599	813604		
	200 <td>813600 <td></td> <td></td> <td></td> </td>	813600 <td></td> <td></td> <td></td>			
	297 <td>813602 <td></td> <td>813603</td> <td>813601</td> </td>	813602 <td></td> <td>813603</td> <td>813601</td>		813603	813601



Pictogram	Size side (mm)	B-7541 Polyester Self-adh. Order Ref.	B-7541 Roll (250/roll) Order Ref.	B-859 Magnetic material Order Ref.	B-7525 Aluminium plate Order Ref.
-----------	----------------	---------------------------------------	-----------------------------------	------------------------------------	-----------------------------------

Oxidizing substance

ADR 5.1	100	257514	223580		
	200 <td>257515 <td></td> <td></td> <td></td> </td>	257515 <td></td> <td></td> <td></td>			
	297 <td>257579 <td></td> <td>258961</td> <td>258962</td> </td>	257579 <td></td> <td>258961</td> <td>258962</td>		258961	258962



Toxic substance

ADR 6.1	100	257518	223582		
	200 <td>257519 <td></td> <td></td> <td></td> </td>	257519 <td></td> <td></td> <td></td>			
	297 <td>257581 <td></td> <td>258967</td> <td>258968</td> </td>	257581 <td></td> <td>258967</td> <td>258968</td>		258967	258968



Radioactive 7A I

ADR 7A	100	811660	811661		
	200 <td>811662 <td></td> <td></td> <td></td> </td>	811662 <td></td> <td></td> <td></td>			
	297 <td>811663 <td></td> <td>811664</td> <td>811665</td> </td>	811663 <td></td> <td>811664</td> <td>811665</td>		811664	811665



Radioactive 7C III

ADR 7C	100	811672	811673		
	200 <td>811674 <td></td> <td></td> <td></td> </td>	811674 <td></td> <td></td> <td></td>			
	297 <td>811675 <td></td> <td>811676</td> <td>811677</td> </td>	811675 <td></td> <td>811676</td> <td>811677</td>		811676	811677



Radioactive 7DA

ADR 7DA	100	223570	223871		
	200 <td>223571 <td></td> <td></td> <td></td> </td>	223571 <td></td> <td></td> <td></td>			
	297 <td>223572 <td></td> <td>223619</td> <td>223620</td> </td>	223572 <td></td> <td>223619</td> <td>223620</td>		223619	223620



Dangerous substance

ADR 9	100	257526	223586		
	200 <td>257527 <td></td> <td></td> <td></td> </td>	257527 <td></td> <td></td> <td></td>			
	297 <td>257585 <td></td> <td>258979</td> <td>258980</td> </td>	257585 <td></td> <td>258979</td> <td>258980</td>		258979	258980

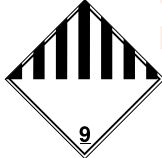

Our complete range of self-adhesive signs for maritime transportation is in accordance with the IMDG-code. By using specified colours and symbols, the nature of the risk can be identified quickly and effectively.

Material: Self-adhesive laminated polyester

Pictogram	Size side (mm)	B-7541 Polyester Self-adh. Order Ref.
-----------	----------------	---------------------------------------

Class 1 : Explosive substances

Explosive		
IMDG 1	100	257537



Class 2 : Non-flammable, flammable gases

Poison gas		
IMDG 2A	100	257538



Oxygen		
IMDG 2B	100	257539



Non-flammable compressed gas		
IMDG 2C	100	257540



Flammable gas		
IMDG 2D	100	257541



Chlorine		
IMDG 2E	100	257542



Class 3: Flammable liquids

Flammable liquid		
IMDG 3A	100	257543



Combustible		
IMDG 3B	100	257544



Pictogram	Size side (mm)	B-7541 Polyester Self-adh. Order Ref.
-----------	----------------	---------------------------------------

Fuel oil		
IMDG 3C	100	257545



Class 4: Flammable solid substances

Flammable solid		
IMDG 4A	100	257546



Spontaneously combustible		
IMDG 4B	100	257547



Dangerous when wet		
IMDG 4C	100	257548



Class 5: Oxidizing substances and organic peroxides

Oxidizing agent		
IMDG 5A	100	257549



Organic peroxide		
IMDG 5B	100	257550



Class 6: Toxic and harmful substances

Harmful		
IMDG 6A	100	257551



Poison		
IMDG 6B	100	257552



Pictogram	Size side (mm)	B-7541 Polyester Self-adh. Order Ref.
-----------	----------------	---------------------------------------

Irritant		
IMDG 6C	100	257553



Infectious substance		
IMDG 6D	100	257554



Class 7: Radioactive substances

Radioactive		
IMDG 7A	100	257555



Class 8: Corrosive substances

Corrosive		
IMDG 8A	100	257557



Class 9: Miscellaneous hazardous substances

Dangerous substance		
IMDG 9A	100	257558

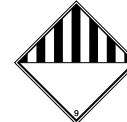

Marine pollutant		
IMDG-MP	100	257559



High temperature		
IMDG-HT	250	251641



Hazardous Substances Identification



New GHS symbols and GHS labels

GHS – The Globally Harmonized System of Classification and Labelling of Chemicals ensures that information on physical hazards and toxicity from chemicals is available in order to enhance the protection of human health and the environment during the handling, transport and use of these chemicals. The GHS also provides a basis for harmonization of rules and regulations on chemicals at national, regional and worldwide level, an important factor also for trade facilitation.

For the European Union, the mandatory effective dates for the implementation are set as follows:

'Pure' Chemical Substances = 01/12/2010 • Mixtures of Chemical Substances = 01/06/2015

GHS labels will replace the HSID labelling system we use currently. That means that the pictogram on an orange square will be replaced by new symbols with a diamond shape. During the transition period between the publication of the European Directive and the effective date, mentioned above, both systems are permitted (HSID and GHS).

GHS Labels

Material: Laminated polyester (self-adhesive) – Available on cards



W x H (mm)	Labels/card	PIC 1801	PIC 1802	PIC 1803	PIC 1804	PIC 1805	PIC 1806	PIC 1807	PIC 1808	PIC 1809
40 x 40	20	811680	811685	811690	811695	811700	811705	811710	811715	811720
70 x 70	6	811682	811687	811692	811697	811702	811707	811712	811717	811722
100 x 100	4	811678	811683	811688	811693	811698	811703	811708	811713	811718

HSID Labels

Material: Laminated polyester (self-adhesive) – Available on cards

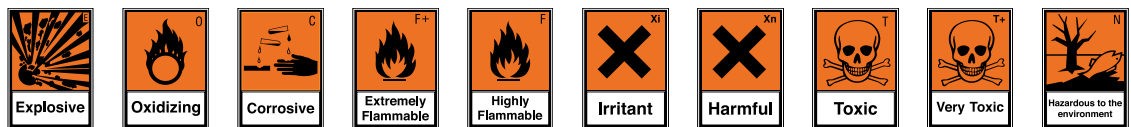

W x H (mm)	Labels/card	STE 584 Order Ref.	STE 585 Order Ref.	STE 586 Order Ref.	STE 587 Order Ref.	STE 588 Order Ref.	STE 589 Order Ref.	STE 590 Order Ref.	STE 591 Order Ref.	STE 592 Order Ref.	STE 593 Order Ref.
15 x 21	35	256458	256462	256466	256470	256474	256478	256482	256486	256490	256494
26 x 37	12	256459	256463	256467	256471	256475	256479	256483	256487	256491	256495
52 x 74	1	256460	256464	256468	256472	256476	256480	256484	256488	256492	256496
105 x 148	1	256461	256465	256469	256473	256477	256481	256485	256489	256493	256497

Blank HSID label

Self-adhesive white paper labels on A4 sheets can easily be printed with substance information on an office printer. The appropriate hazard symbol label can then be stuck to the printed paper label and a clear self-adhesive polyester overlaminated label can be stuck over the top to fully protect the information printed underneath.



Blank labels

Order Ref.	Size (mm)	Material	Labels/pack	A4 sheets/pack	Labels/sheet
310131	74 x 52	Paper	512	32	16
310132	105 x 74	Paper	504	63	8
310133	148 x 105	Paper	500	125	4
310134	210 x 148	Paper	500	250	2

Polyester laminate for protection

Order Ref.	Size (mm)	Material	Quantity/pack
213300	84 x 62	Transparent Polyester	2500
213301	115 x 84	Transparent Polyester	1000
213302	158 x 115	Transparent Polyester	500
213303	220 x 158	Transparent Polyester	500

Packaging Labels

Material: Laminated polyester (self-adhesive)

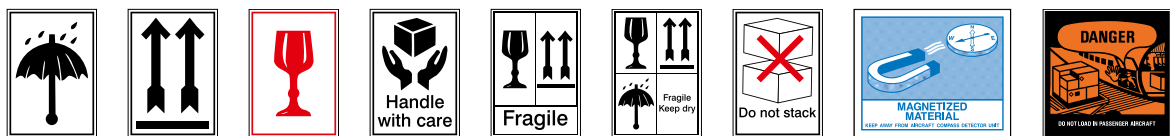

W x H (mm)	PIC 10 Order Ref.	ADR 11 Order Ref.	PIC 12 Order Ref.	STE 13 Order Ref.	STE 14 Order Ref.	STE 15 Order Ref.	STE 16 Order Ref.	TIR M Order Ref.	TIR A Order Ref.
74 x 105	257528	257530	257532	-	-	-	-	-	-
110 x 90	-	-	-	-	-	-	-	276260	-
121 x 110	-	-	-	-	-	-	-	-	276262
148 x 210	257529	257531	257533	251642	251643	251644	251645	-	-

PIC 667

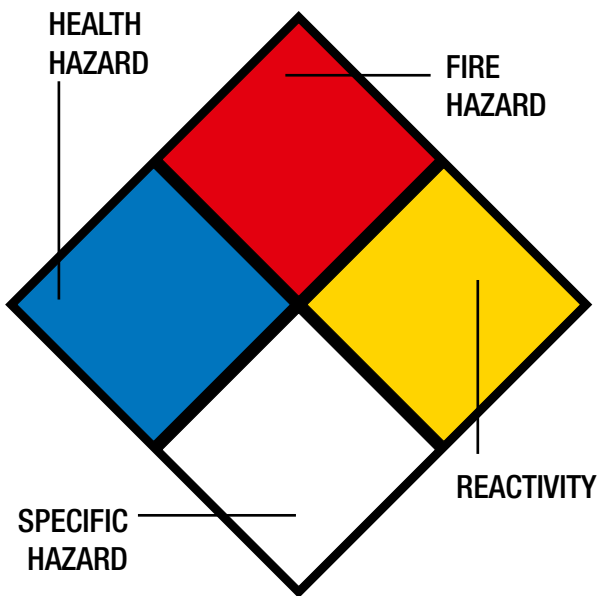

The NFPA* Diamond and the New Colour Bar above are the two most commonly used chemical label warning systems. These systems identify the hazards of a material by four principal categories:

- **Health Hazard** – which ranks the specific material's probable severity to personal health
- **Fire Hazard** – which ranks the specific material's susceptibility to burn
- **Reactivity** – which ranks the specific material's ease, rate and quantity of energy released.
- **Specific Hazard** – which identifies the specific material's special hazard potential or any special protection which may be required

Use the chart below when determining the specific rating to be used to identify each of the above specified hazards.

* NFPA – National Fire Protection Association Hazardous Material Signal

NFPA Placard: PIC 667

Size W x H (mm)	B-7541 Polyester	B-7525 Aluminium plate	B-589 Magnetic foil
100 x 100	223906	223910	223962
200 x 200	223907	223911	223963
300 x 300	223908	223912	223964
400 x 400	223909	223913	223965



NFPA Placard Kit

- Kit allows you to customize placards on the spot
- Placards available in self-adhesive vinyl
- Vinyl kits come complete with 10 blank NFPA placards, and 10 characters each of 0 to 4, W, , OXY, ACID, COR and ALK

Material	Quantity	Size pictogram (mm)	Character Size (mm)	Order Ref.
Vinyl	10	250	100	050053
Vinyl	10	380	150	050054
Reflective (B-997)	10	130	–	058272
Reflective (B-997)	10	190	–	058273
Reflective (B-997)	10	250	–	058274

RATING EXPLANATION GUIDE

HEALTH		FLAMMABLE		REACTIVE	
Recommended Protection		Susceptibility to Burning		Susceptibility to Energy Release	
4	Special full protection suite and breathing apparatus must be worn	4	Very Flammable	4	May detonate under normal conditions
3	Full protective suit and breathing apparatus should be worn	3	Ignites under normal temperature conditions	3	May detonate with shock or heat
2	Breathing apparatus with full face mask should be worn	2	Ignites with moderate heating	2	Violent chemical change but does not detonate
1	Breathing apparatus may be worn	1	Ignites when preheated	1	Not stable if heated use precautions
0	No precautions necessary	0	Will not ignite	0	Normally stable





BradyGlo™ IMO Safety Signs

Having an efficient evacuation procedure in case of emergencies is of major importance for the safety of your work force, visitors and members of the general public. Reports of incidents with ferries, tankers, cruisers, offshore oil rigs and airports reach us on a daily basis. Emergency situations are unpredictable and even in the most controlled areas, human errors and technical shortcomings cannot be ruled out completely.

Any public environment or building where large concentrations of public visitors can be found, requires the highest level of clearly defined safety signage. In an emergency situation verbal assistance and direction is often inadequate; people will almost instinctively look for the signs to guide them to safety.

BradyGlo™ is a product designed to give the most flexible and efficient form of guidance in extremely demanding emergency situations. **BradyGlo™** ensures clear escape directions, even in cases of complete power failure. Many emergency situations can create, or may in fact require, the complete shutdown of all electrical power.

BradyGlo™ is a product that both meets and exceeds the standards set by legislation (DIN 67510, IMO A.752 (18)). The luminous intensity of **BradyGlo™** – Standard is even 3 times better than DIN 67510 and **BradyGlo™** – Plus is up to 7 times better.

The **BradyGlo™** IMO (International Marine Organisation) range is manufactured from rigid PVC of the highest quality and has been approved by Lloyd's Register, Rina and Kema. The **BradyGlo™** signs are suitable for both indoor and outdoor usage and contain no radioactive components. **BradyGlo™** is composed of mainly white photoluminescent pigments and requires no maintenance.

SAFETY SIGNS

	Luminous intensity after 10 min. mcd/m ²	Luminous intensity after 60 min. mcd/m ²	Decreasing time luminance as mcd/m ² in min.
1. IMO Resolution A.752 (18)	15	2	–
2. DIN 67510	20	2.8	340
3. BradyGlo™ Standard	71.1	9.9	1203
4. BradyGlo™ Plus	147.3	21.3	2519

BRADYGLO™ STANDARD
Up to 3 times better than IMO/DIN

BRADYGLO™ PLUS
Up to 7 times better than IMO/DIN

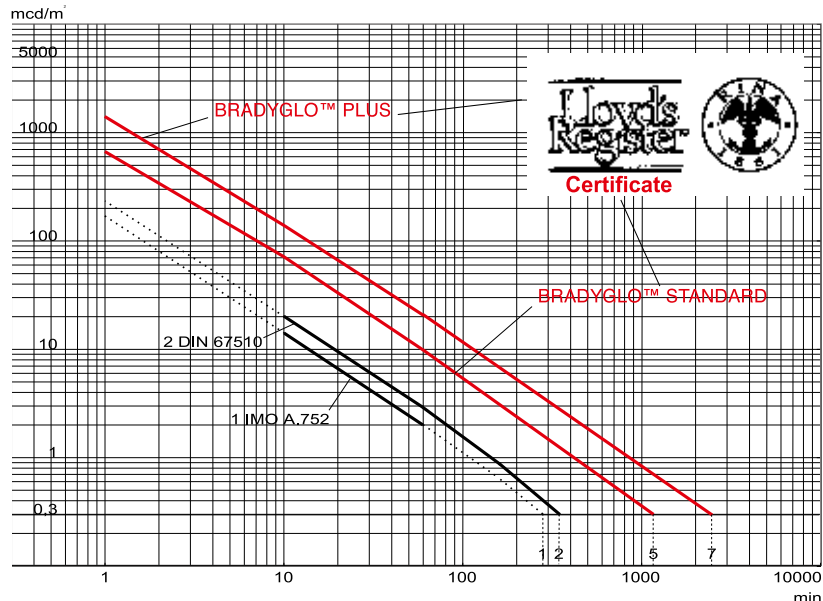

Fire Control / Protection

Pictogram	Size (mm)	PVC B-7537 1 mm Order Ref.
-----------	-----------	----------------------------------

Fire control plan
IMO 101 150 x 150 ISSA: 47.501.01
IM1501KS39



Push button/switch for fire alarm
IMO 102 150 x 150 ISSA: 47.501.02
IM1502KS39



Horn fire alarm
IMO 103 150 x 150 ISSA: 47.501.03
IM1503KS39



Fire alarm
IMO 104 150 x 150 ISSA: 47.501.04
IM1504KS39



Manually operated call point
IMO 105 150 x 150 ISSA: 47.501.05
IM1505KS39



Space protected by automatic fire alarm
IMO 106 150 x 150 ISSA: 47.501.06
IM1506KS39



Space protected by CO₂
IMO 107 150 x 150 ISSA: 47.501.07
IM1507KS39



CO₂ horn
IMO 108 150 x 150 ISSA: 47.501.08
IM1508KS39



CO₂ release station
IMO 109 150 x 150 ISSA: 47.501.09
IM1509KS39



Halon 1301 battery
IMO 110 150 x 150 ISSA: 47.501.10
IM1510KS39



Space protected by Halon 1301
IMO 111 150 x 150 ISSA: 47.501.11
IM1511KS39



Halon horn
IMO 112 150 x 150 ISSA: 47.501.12
IM1512KS39



Pictogram	Size (mm)	PVC B-7537 1 mm Order Ref.
-----------	-----------	----------------------------------

Foam installation
IMO 113 150 x 150 ISSA: 47.501.13
IM1513KS39



Foam monitor (gun)
IMO 114 150 x 150 ISSA: 47.501.14
IM1514KS39



Foam nozzle
IMO 115 150 x 150 ISSA: 47.501.15
IM1515KS39



Foam applicator
IMO 116 150 x 150 ISSA: 47.501.16
IM1516KS39



Foam valve
IMO 117 150 x 150 ISSA: 47.501.17
IM1517KS39



Foam release station
IMO 118 150 x 150 ISSA: 47.501.18
IM1518KS39



Emergency fire pump
IMO 119 150 x 150 ISSA: 47.501.19
IM1519KS39



Remote controlled fire pumps
IMO 120 150 x 150 ISSA: 47.501.20
IM1520KS39



Bilge pump
IMO 121 150 x 150 ISSA: 47.501.21
IM1521KS39



Emergency bilge pump
IMO 122 150 x 150 ISSA: 47.501.22
IM1522KS39



Water monitor (gun)
IMO 123 150 x 150 ISSA: 47.501.23
IM1523KS39



Water for applicator
IMO 124 150 x 150 ISSA: 47.501.24
IM1524KS39



Pictogram	Size (mm)	PVC B-7537 1 mm Order Ref.
-----------	-----------	----------------------------------

Emergency telephone station
IMO 125 150 x 150 ISSA: 47.501.25
IM1525KS39



Fire axe
IMO 126 150 x 150 ISSA: 47.501.26
IM1526KS39



Drenching installation
IMO 127 150 x 150 ISSA: 47.501.27
IM1527KS39



Space protected by drenching system
IMO 128 150 x 150 ISSA: 47.501.28
IM1528KS39



Section valves drenching system
IMO 129 150 x 150 ISSA: 47.501.29
IM1529KS39



Fire station
IMO 130 150 x 150 ISSA: 47.501.30
IM1530KS39



A class division
IMO 131 150 x 150 ISSA: 47.501.31
IM1531KS39



A class fire door
IMO 132 150 x 150 ISSA: 47.501.32
IM1532KS39



A class self-closing fire door
IMO 133 150 x 150 ISSA: 47.501.33
IM1533KS39



All signs are certified by:



Fire Control / Protection

Pictogram **Size (mm)** **PVC B-7537 1 mm Order Ref.**

A class fire door
IMO 134 150 x 150 ISSA: 47.501.34
IM1534KS39



A class self-closing fire door
IMO 135 150 x 150 ISSA: 47.501.35
IM1535KS39



Portable foam applicator
IMO 136 150 x 150 ISSA: 47.501.36
IM1536KS39



B class division
IMO 137 150 x 150 ISSA: 47.501.37
IM1537KS39



B class fire door
IMO 138 150 x 150 ISSA: 47.501.38
IM1538KS39



B class self-closing fire door
IMO 139 150 x 150 ISSA: 47.501.39
IM1539KS39



B class fire door
IMO 140 150 x 150 ISSA: 47.501.40
IM1540KS39



B class self-closing fire door
IMO 141 150 x 150 ISSA: 47.501.41
IM1541KS39



Main vertical zone
IMO 142 150 x 150 ISSA: 47.501.42
IM1542KS39



Fire alarm panel
IMO 143 150 x 150 ISSA: 47.501.43
IM1543KS39



Sprinkler installation
IMO 144 150 x 150 ISSA: 47.501.44
IM1544KS39



Sprinkler
IMO 145 150 x 150 ISSA: 47.501.45
IM1545KS39



Pictogram **Size (mm)** **PVC B-7537 1 mm Order Ref.**

Sprinkler horn
IMO 146 150 x 150 ISSA: 47.501.46
IM1546KS39



Sprinkler section valves
IMO 147 150 x 150 ISSA: 47.501.47
IM1547KS39



CO₂ battery
IMO 148 150 x 150 ISSA: 47.501.48
IM1548KS39



Halon release station
IMO 149 150 x 150 ISSA: 47.501.49
IM1549KS39



Halon 1301 bottles placed in protected area
IMO 150 150 x 150 ISSA: 47.501.50
IM1550KS39



Powder installation
IMO 151 150 x 150 ISSA: 47.501.51
IM1551KS39



Powder monitor (gun)
IMO 152 150 x 150 ISSA: 47.501.52
IM1552KS39



Powder hose and handgun
IMO 153 150 x 150 ISSA: 47.501.53
IM1553KS39



Powder release station
IMO 154 150 x 150 ISSA: 47.501.54
IM1554KS39



Flame detector
IMO 155 150 x 150 ISSA: 47.501.55
IM1555KS39



Smoke detector
IMO 156 150 x 150 ISSA: 47.501.56
IM1556KS39



Fire main with fire valves
IMO 157 150 x 150 ISSA: 47.501.57
IM1557KS39



Pictogram **Size (mm)** **PVC B-7537 1 mm Order Ref.**

Hose box with spray / jet fire nozzle
IMO 158 150 x 150 ISSA: 47.501.58
IM1558KS39



International shore connection
IMO 159 150 x 150 ISSA: 47.501.59
IM1559KS39



Fire pump
IMO 160 150 x 150 ISSA: 47.501.60
IM1560KS39



Heat detector
IMO 161 150 x 150 ISSA: 47.501.61
IM1561KS39



Gas detector
IMO 162 150 x 150 ISSA: 47.501.62
IM1562KS39



Fire damper in vent duct
IMO 163 150 x 150 ISSA: 47.501.63
IM1563KS39



Remote controlled skylights
IMO 164 150 x 150 ISSA: 47.501.64
IM1564KS39



Remote controlled fuel / lubricated oil valves
IMO 165 150 x 150 ISSA: 47.501.65
IM1565KS39



Control station
IMO 166 150 x 150 ISSA: 47.501.66
IM1566KS39



Locker with fireman's outfit
IMO 167 150 x 150 ISSA: 47.501.67
IM1567KS39



Breathing apparatus
IMO 168 150 x 150 ISSA: 47.501.68
IM1568KS39



Locker with protective clothing
IMO 169 150 x 150 ISSA: 47.501.69
IM1569KS39



Fire Control / Protection

Pictogram	Size (mm)	PVC B-7537 1 mm Order Ref.
-----------	-----------	----------------------------------

Primary escape route IMO 170	150 x 150	ISSA: 47.501.70 IM1570KS39
---------------------------------	-----------	-------------------------------



Secondary escape route IMO 171	150 x 150	ISSA: 47.501.71 IM1571KS39
-----------------------------------	-----------	-------------------------------



Closing appliance for ext. ventil inlet or outlet IMO 172	150 x 150	ISSA: 47.501.72 IM1572KS39
--------------------------------------------------------------	-----------	-------------------------------



Inert gas installation IMO 173	150 x 150	ISSA: 47.501.73 IM1573KS39
-----------------------------------	-----------	-------------------------------



High expansion foam supply tank IMO 174	150 x 150	ISSA: 47.501.74 IM1574KS39
--------------------------------------------	-----------	-------------------------------



CO ₂ / Nitrogen bulk installation IMO 175	150 x 150	ISSA: 47.501.75 IM1575KS39
---------------------------------------------------------	-----------	-------------------------------



Emergency generator IMO 176	150 x 150	ISSA: 47.501.76 IM1576KS39
--------------------------------	-----------	-------------------------------



Emergency switchboard IMO 177	150 x 150	ISSA: 47.501.77 IM1577KS39
----------------------------------	-----------	-------------------------------



Remote ventilation shut off IMO 178	150 x 150	ISSA: 47.501.78 IM1578KS39
----------------------------------------	-----------	-------------------------------



Portable fire extinguisher P6 IMO 179	150 x 150	ISSA: 47.501.79 IM1579KS39
------------------------------------------	-----------	-------------------------------



Portable fire extinguisher LW9 IMO 180	150 x 150	ISSA: 47.501.79 IM1580KS39
-------------------------------------------	-----------	-------------------------------



Portable fire extinguisher Halon 1211/4 IMO 181	150 x 150	ISSA: 47.501.79 IM1581KS39
----------------------------------------------------	-----------	-------------------------------



Pictogram	Size (mm)	PVC B-7537 1 mm Order Ref.
-----------	-----------	----------------------------------

Portable fire extinguisher CO ₂ /2 IMO 182	150 x 150	ISSA: 47.501.79 IM1582KS39
----------------------------------------------------------	-----------	-------------------------------



Portable fire extinguisher P2 IMO 183	150 x 150	ISSA: 47.501.79 IM1583KS39
------------------------------------------	-----------	-------------------------------



Portable fire extinguisher P1 IMO 184	150 x 150	ISSA: 47.501.79 IM1584KS39
------------------------------------------	-----------	-------------------------------



Wheeled fire extinguisher P50 IMO 185	150 x 150	ISSA: 47.501.79 IM1585KS39
------------------------------------------	-----------	-------------------------------



Wheeled fire extinguisher CO ₂ /30 IMO 186	150 x 150	ISSA: 47.501.79 IM1586KS39
----------------------------------------------------------	-----------	-------------------------------



Fire extinguisher IMO 401	150 x 150	ISSA: 47.509.13 IM1501KS30
------------------------------	-----------	-------------------------------



Fire alarm IMO 402	150 x 150	ISSA: 47.509.11 IM1502KS30
-----------------------	-----------	-------------------------------



Fire hose reel IMO 403	150 x 150	ISSA: 47.509.15 IM1503KS30
---------------------------	-----------	-------------------------------



Emergency phone IMO 404	150 x 150	ISSA: 47.509.19 IM1504KS30
----------------------------	-----------	-------------------------------



Fire point IMO 405	150 x 150	ISSA: 47.509.17 IM1505KS30
-----------------------	-----------	-------------------------------



This way IMO 406	150 x 150	ISSA: 47.509.43 IM1506KS30
---------------------	-----------	-------------------------------



This way IMO 407	150 x 150	ISSA: 47.509.45 IM1507KS30
---------------------	-----------	-------------------------------



Pictogram	Size (mm)	PVC B-7537 1 mm Order Ref.
-----------	-----------	----------------------------------

Level / Floor 0 IMO 421	150 x 150	IM1521KS30
----------------------------	-----------	------------



Level / Floor 1 IMO 422	150 x 150	IM1522KS30
----------------------------	-----------	------------



Level / Floor 2 IMO 423	150 x 150	IM1523KS30
----------------------------	-----------	------------



Level / Floor 3 IMO 424	150 x 150	IM1524KS30
----------------------------	-----------	------------



Level / Floor 4 IMO 425	150 x 150	IM1525KS30
----------------------------	-----------	------------



Level / Floor 5 IMO 426	150 x 150	IM1526KS30
----------------------------	-----------	------------



Level / Floor 6 IMO 427	150 x 150	IM1527KS30
----------------------------	-----------	------------



Level / Floor 7 IMO 428	150 x 150	IM1528KS30
----------------------------	-----------	------------



Level / Floor 8 IMO 429	150 x 150	IM1529KS30
----------------------------	-----------	------------



Level / Floor 9 IMO 430	150 x 150	IM1530KS30
----------------------------	-----------	------------



Evacuation & First Aid

Pictogram **Size (mm)** **PVC B-7537 1 mm Order Ref.**

Lifeboat
IMO 301 150 x 150 ISSA: 47.502.11
IM1501KS60



Rescue boat
IMO 302 150 x 150 ISSA: 47.502.12
IM1502KS60



Life raft
IMO 303 150 x 150 ISSA: 47.502.13
IM1503KS60



Davit launched life raft
IMO 304 150 x 150 ISSA: 47.502.14
IM1504KS60



Embarkation ladder
IMO 305 150 x 150 ISSA: 47.502.15
IM1505KS60



Evacuation slide
IMO 306 150 x 150 ISSA: 47.502.16
IM1506KS60



Life buoy
IMO 307 150 x 150 ISSA: 47.502.17
IM1507KS60



Life buoy with line
IMO 308 150 x 150 ISSA: 47.502.18
IM1508KS60



Life buoy with light
IMO 309 150 x 150 ISSA: 47.502.19
IM1509KS60



Life buoy with light and smoke
IMO 310 150 x 150 ISSA: 47.502.20
IM1510KS60



Life jacket
IMO 311 150 x 150 ISSA: 47.502.21
IM1511KS60



Pictogram **Size (mm)** **PVC B-7537 1 mm Order Ref.**

Child's life jacket
IMO 312 150 x 150 ISSA: 47.502.22
IM1512KS60



Immersion suit
IMO 313 150 x 150 ISSA: 47.502.23
IM1513KS60



Survival craft portable radio
IMO 314 150 x 150 ISSA: 47.502.24
IM1514KS60



Navigation guide EPIRB
IMO 315 150 x 150 ISSA: 47.502.25
IM1515KS60



Radar transponder
IMO 316 150 x 150 ISSA: 47.502.26
IM1516KS60



Survival craft pyrotechnic distress signals
IMO 317 150 x 150 ISSA: 47.502.27
IM1517KS60



Rocket parachute flares
IMO 318 150 x 150 ISSA: 47.502.28
IM1518KS60



Line throwing appliance
IMO 319 150 x 150 ISSA: 47.502.29
IM1519KS60



Pictogram **Size (mm)** **PVC B-7537 1 mm Order Ref.**

Meeting point
IMO 320 150 x 150 ISSA: 47.502.30
IM1520KS60



This way
IMO 321 150 x 150 ISSA: 47.506.37
IM1521KS60



This way
IMO 322 150 x 150 ISSA: 47.506.38
IM1522KS60



Emergency ladder
IMO 323 150 x 150 ISSA: 47.506.39
IM1523KS60



First aid
IMO 324 150 x 150 ISSA: 47.506.29
IM1524KS60



Escape route right
IMO 325 150 x 150 ISSA: 47.506.30
IM1525KS60



Escape route left
IMO 326 150 x 150 ISSA: 47.506.31
IM1526KS60



Eye wash
IMO 327 150 x 150 ISSA: 47.506.29
IM1527KS60



Emergency stop
IMO 328 150 x 150 ISSA: 47.506.27
IM1528KS60



Emergency phone
IMO 329 150 x 150 ISSA: 47.506.35
IM1529KS60



Emergency shower
IMO 330 150 x 150 ISSA: 47.506.31
IM1530KS60



Evacuation & First Aid

Pictogram	Size (mm)	PVC B-7537 1 mm Order Ref.
-----------	-----------	----------------------------------

Level / Floor 0 IMO 331	75 x 150	ISSA: 47.503.01 IM1531KS60
----------------------------	----------	-------------------------------



Level / Floor 1 IMO 332	75 x 150	ISSA: 47.503.03 IM1532KS60
----------------------------	----------	-------------------------------



Level / Floor 2 IMO 333	75 x 150	ISSA: 47.503.05 IM1533KS60
----------------------------	----------	-------------------------------



Level / Floor 3 IMO 334	75 x 150	ISSA: 47.503.07 IM1534KS60
----------------------------	----------	-------------------------------



Level / Floor 4 IMO 335	75 x 150	ISSA: 47.503.09 IM1535KS60
----------------------------	----------	-------------------------------



Level / Floor 5 IMO 336	75 x 150	ISSA: 47.503.11 IM1536KS60
----------------------------	----------	-------------------------------



Level / Floor 6 IMO 337	75 x 150	ISSA: 47.503.13 IM1537KS60
----------------------------	----------	-------------------------------



Level / Floor 7 IMO 338	75 x 150	ISSA: 47.503.15 IM1538KS60
----------------------------	----------	-------------------------------



Level / Floor 8 IMO 339	75 x 150	ISSA: 47.503.17 IM1539KS60
----------------------------	----------	-------------------------------



Level / Floor 9 IMO 340	75 x 150	ISSA: 47.503.19 IM1540KS60
----------------------------	----------	-------------------------------



Pictogram	Size (mm)	PVC B-7537 1 mm Order Ref.
-----------	-----------	----------------------------------

Drinking water IMO 341	150 x 150	IM1541KS60
---------------------------	-----------	------------



Permission to... IMO 342	150 x 150	IM1542KS60
-----------------------------	-----------	------------



Stairway IMO 343	150 x 150	IM1543KS60
---------------------	-----------	------------



Thermal protective aid IMO 344	150 x 150	IM1544KS60
-----------------------------------	-----------	------------



Anti exposure suit IMO 345	150 x 150	IM1545KS60
-------------------------------	-----------	------------



Exit IMO 351	300 x 150	IM1551KS60
-----------------	-----------	------------



Smoking area IMO 352	300 x 150	IM1552KS60
-------------------------	-----------	------------



Eating and drinking area IMO 353	300 x 150	IM1553KS60
-------------------------------------	-----------	------------



Obligation

Pictogram	Size (mm)	PVC B-7537 1 mm Order Ref.
-----------	-----------	----------------------------------

Fasten seat belts IMO 201	150 x 150	ISSA: 47.502.01 IM1501KS50
------------------------------	-----------	-------------------------------



Secure hatches IMO 202	150 x 150	ISSA: 47.502.02 IM1502KS50
---------------------------	-----------	-------------------------------



Start engine IMO 203	150 x 150	ISSA: 47.502.03 IM1503KS50
-------------------------	-----------	-------------------------------



Lower lifeboat to water IMO 204	150 x 150	ISSA: 47.502.04 IM1504KS50
------------------------------------	-----------	-------------------------------



Lower life raft to water IMO 205	150 x 150	ISSA: 47.502.05 IM1505KS50
-------------------------------------	-----------	-------------------------------



Lower rescue boat to water IMO 206	150 x 150	ISSA: 47.502.06 IM1506KS50
---------------------------------------	-----------	-------------------------------



Release falls IMO 207	150 x 150	ISSA: 47.502.07 IM1507KS50
--------------------------	-----------	-------------------------------



Start water spray IMO 208	150 x 150	ISSA: 47.502.08 IM1508KS50
------------------------------	-----------	-------------------------------





Start air supply IMO 209	150 x 150	ISSA: 47.502.09 IM1509KS50
-----------------------------	-----------	-------------------------------



Release grips IMO 210	150 x 150	ISSA: 47.502.10 IM1510KS50
--------------------------	-----------	-------------------------------



All signs are certified by:

Low-Location-Light System

The **BradyGlo™** range also offers a Low-Location-Light system that does not require any external power source. Your escape route indicators will stay clearly visible, even in complete darkness. Because it does not operate on batteries either, the **BradyGlo™** Low-Location-Light system can be installed in places where even the smallest ignition is unacceptable. In many cases of fires inside buildings or on sites of an industrial nature, sight will be limited by smoke. The **BradyGlo™** range includes signs and direction indicators that can be applied close to the ground, enabling people to find their way out under extreme conditions.



Aluminium slide-in profiles

Order Ref.	Description	Standard package
EL1004AL	Aluminium slide-in profile – 1000mm x 40mm	1 pc
EL3004AL	Aluminium slide-in profile – 3000mm x 40mm	1 pc
EL1008AL	Aluminium slide-in profile – 1000mm x 80mm	1 pc
EL3008AL	Aluminium slide-in profile – 3000mm x 80mm	1 pc

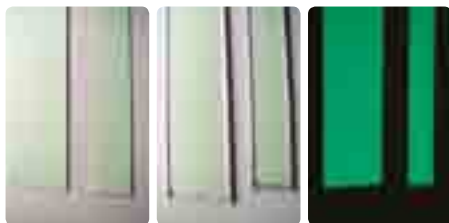

BradyGlo™ slide-in plate



Order Ref.	Description	Standard package
ES1004KS	PVC BradyGlo™ slide-in plate – 1000mm x 35mm	1 pc
ES1008KS	PVC BradyGlo™ slide-in plate – 1000mm x 74mm	1 pc







Aluminium end cap

Order Ref.	Description	Standard package
EK1800AL	Aluminium end cap – 18mm x 35mm	1 pc
EK3600AL	Aluminium end cap – 18mm x 74mm	1 pc

PVC slide-in pictograms

Pictogram	Size (w x h) (mm)	PVC 0,2 mm Order Ref.
Fire hose	36 x 35	IM1803KS30
IMO 403	72 x 74	IM3603KS30
		
Emergency telephone	36 x 35	IM1804KS30
IMO 404	72 x 74	IM3604KS30
		
Fire point	36 x 35	IM1805KS30
IMO 405	72 x 74	IM3605KS30
		

Pictogram	Size (w x h) (mm)	PVC 0,2 mm Order Ref.
Meeting point	36 x 35	IM1820KS60
IMO 320	72 x 74	IM3620KS60
		
This way	36 x 35	IM1821KS60
IMO 321	72 x 74	IM3621KS60
		
This way	36 x 35	IM1822KS60
IMO 322	72 x 74	IM3622KS60
		

Pictogram	Size (w x h) (mm)	PVC 0,2 mm Order Ref.
Stairs	36 x 35	IM1843KS60
IMO 343	72 x 74	IM3643KS60
		
Exit	144 x 35	IM1851KS60
IMO 351	144 x 74	IM3651KS60
		



All Brady Signs are available in your local language. Contact Brady Customer Service for more information

Safety Equipment Storage Solutions



Safety Stop Station

- Combines both the safety message and the required safety equipment needed at one convenient location.
- Constructed of durable red and clear acrylic.
- Use indoors or outdoors.
- Mount to a wall or use as a stand-alone sign (Post and base are available on request).

Station size: 92 cm H x 46 cm W

Contents not included

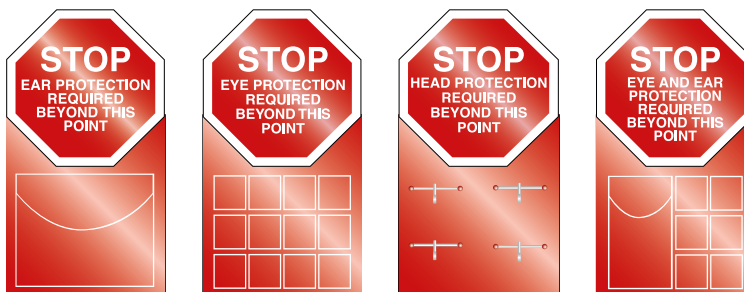

Order Ref.	050916	050914	050917	050915
Station stores:	200 pairs of earplugs	12 pairs of glasses	4 hard hats	6 pairs of glasses 100 pairs of earplugs

Storage Units for Safety Equipment

Ensures individual usage and makes a valuable contribution to your general safety signage.

- Improves the safety of your personnel: the protective equipment is available where and when you need it (work place, machine, industrial site).
- Ownership and hygiene are ensured; the equipment is safeguarded from dirt, dust and water spray.
- The plastic unit can be mounted with either adhesive or screws.
- Blue front and sign in accordance with safety sign regulations.

Packaging: 1



Model	Size
Small:	23.6 x 12 x 12 cm
Medium	23.6 x 22.5 x 12.5 cm
Large	23.6 x 31.5 x 20 cm
Multibox 4	23.6 x 22.5 x 20 cm (holds 4 pairs of glasses)
Multibox 12	23.6 x 31.5 x 20 cm (holds 12 pairs of glasses)



Order Ref.	Model	Sign (equipment)	
224044	Small	Wear gloves	
223925	Small	Wear eye protection	
223926	Medium	Wear ear protection	
223927	Medium	Wear ear and eye protection	
223928	Medium	Wear mask	
223929	Medium	Wear gloves	
223930	Large	Wear hard hat	
223931	Large	Wear hard hat and ear protection	
223932	Large	Wear respiratory equipment	
223961	Multibox 4	Wear eye protection	
224045	Multibox 12	Wear eye protection	

SAFETY SIGNS



Storage Unit for Visitor Safety Equipment

Ensure the safety of your visitors!

Brady offers you a practical storage unit combined with a sign in accordance with the safety sign regulations. Place this unit at your reception desk, at the entrance of buildings, or at the start of a danger zone where wearing specific safety equipment is obligatory: labs, workshops, etc. especially for visitors and maintenance personnel. Can be attached with adhesive or screws.

Material: transparent semi-rigid polypropylene

Size: whole unit A4 (210 x 297 mm) – holder is 150 x 150 x 210 mm – sign 200 mm diameter

3 available types:

- Safety glass storage unit
- Eye protection storage unit
- Blank box

Other pictograms are available on request.

Order Ref.	Description
223933	Eye protection
223935	Ear protection
223960	Blank box



1. Bradyfoam™ Mounting Tape

- White polypropylene tape, is coated on both sides with high-tack, high-shear synthetic rubber adhesive for indoor and outdoor use.
- Bonds well to rough, irregular surfaces.
- Minimum application temperature: 10°C.

Order Ref.	Size	Packaging
078273	19 mm x 33 m	1 Roll
227599	19 mm x 33 m (3M)	1 Roll
019811	25 mm x 33 m	1 Roll
EL3008AL	Aluminium slide-in profile – 3000mm x 80mm	1 pc

Order Ref.	Size	Packaging
097200	19 mm x 11.4 cm (4/card)	1 Card



2. Transparent Dual Lock Fasteners

- Invisible and strong fastening, yet easy to reopen.
- High tack adhesive: sticks to a variety of materials.
- Moisture and UV resistant.

Order Ref.	Size	Packaging
256456	25 mm x 5 m	1 box (2 rolls)



3. Magnetic Strips

- Magnetic mounting strips with pressure sensitive adhesive on one side.

Order Ref.	Size	Packaging
058301	25 mm x 100 m	10 strips



4. Cold Temperature Mounting Strips

- Use to mount signs indoors or outdoors.
- May be applied at temperatures as low as -57°C.
- Strips have adhesive on both sides.

Order Ref.	Size	Packaging
055717	25 mm x 16 m	1 Roll

How to order

1. Use the Part Number corresponding with the desired layout and size.
2. Select a sign type (emergency/first aid, fire equipment, mandatory, prohibition, warning)
3. Select a symbol from page 65 or from other pages in this catalogue. Upon ordering, clearly state the PIC number, or refer to the part number of the sign from which you wish to use the symbol. Custom symbols can be used, if supplied in the appropriate file format (eps or Corel Draw).
4. Add your text.

Layout 1

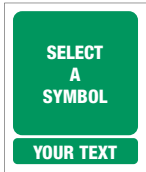

Emergency/
First Aid

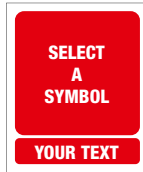

Fire Equipment

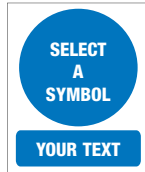

Mandatory



Prohibition

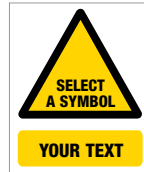

Warning

Size (mm)	Self-adhesive Polyester	Rigid Polypropylene
150 x 125	800019	800023
300 x 250	800020	800024
594 x 480 (A2)	800021	800025
840 x 595 (A1)	800022	800026

Layout 2

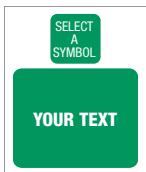

Emergency/
First Aid



Fire Equipment

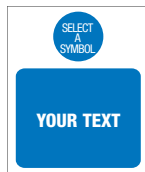

Mandatory



Prohibition



Warning

Size (mm)	Self-adhesive Polyester	Rigid Polypropylene
150 x 125	800027	800031
300 x 250	800028	800032
594 x 480 (A2)	800029	800033
840 x 595 (A1)	800030	800034

Layout 3

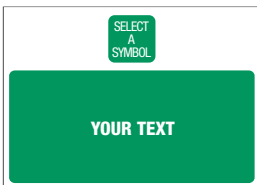

Emergency/First Aid

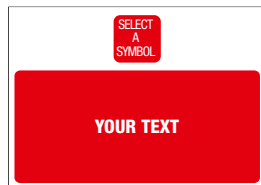

Fire Equipment

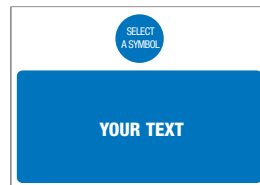

Mandatory



Prohibition



Warning

Size (mm)	Self-adhesive Polyester	Rigid Polypropylene
250 x 350	800035	800036

Layout 4



Emergency/First Aid



Fire Equipment



Mandatory



Prohibition



Warning

Size (mm)	Self-adhesive Polyester	Rigid Polypropylene
50 x 150	800037	800040
100 x 300	800038	800041
200 x 600	800039	800042

Layout 5

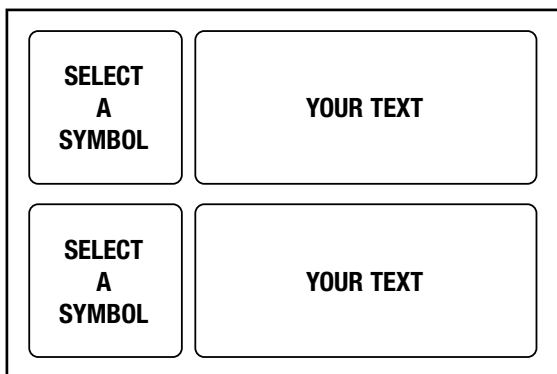

Size (mm)	Self-adhesive Polyester	Rigid Polypropylene
300 x 450	800043	800045
400 x 600	800044	800046

Select any two of these styles to make up your custom Multi-Message Sign

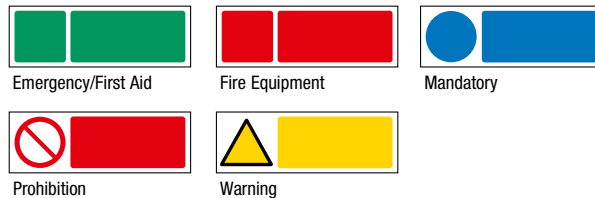

Layout 6

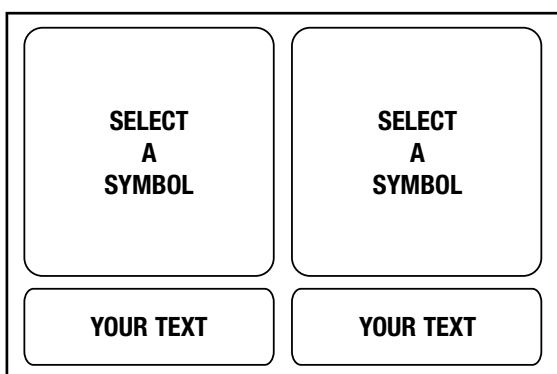

Size (mm)	Self-adhesive Polyester	Rigid Polypropylene
300 x 450	800047	800049
400 x 600	800048	800050

Select any two of these styles to make up your custom Multi-Message Sign

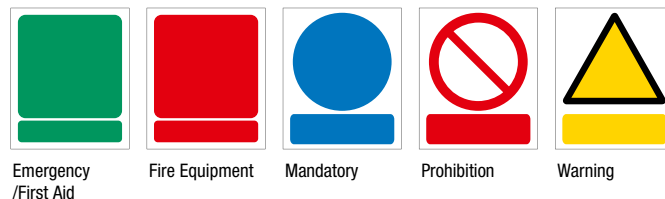

Layout 7

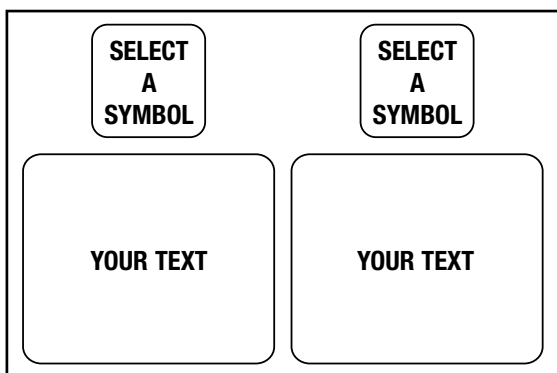

Size (mm)	Self-adhesive Polyester	Rigid Polypropylene
300 x 450	800051	800053
400 x 600	800052	800054

Select any two of these styles to make up your custom Multi-Message Sign

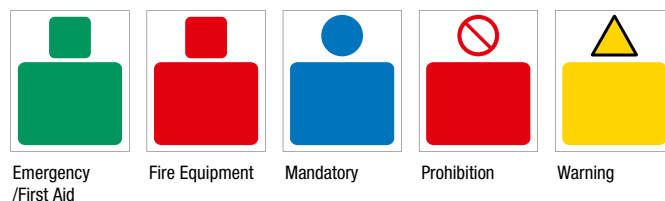

Layout 8

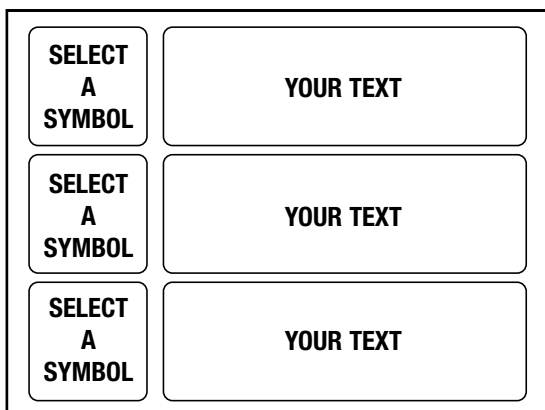

Size (mm)	Self-adhesive Polyester	Rigid Polypropylene
300 x 450	800055	800057
400 x 600	800056	800058

Select any two of these styles to make up your custom Multi-Message Sign

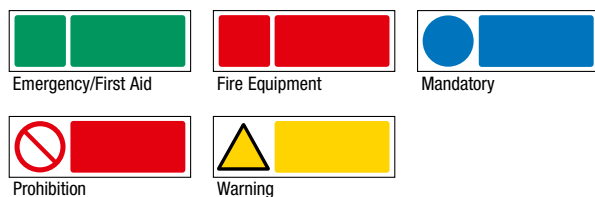

Standard Safety Symbols

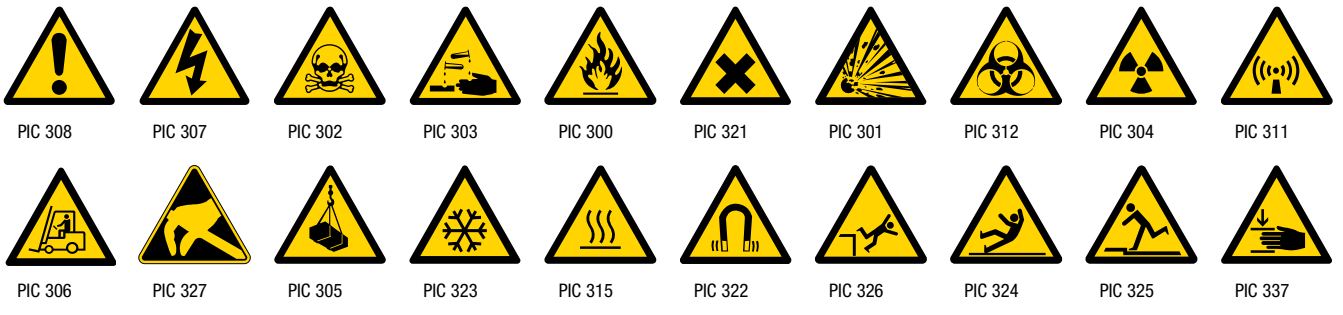
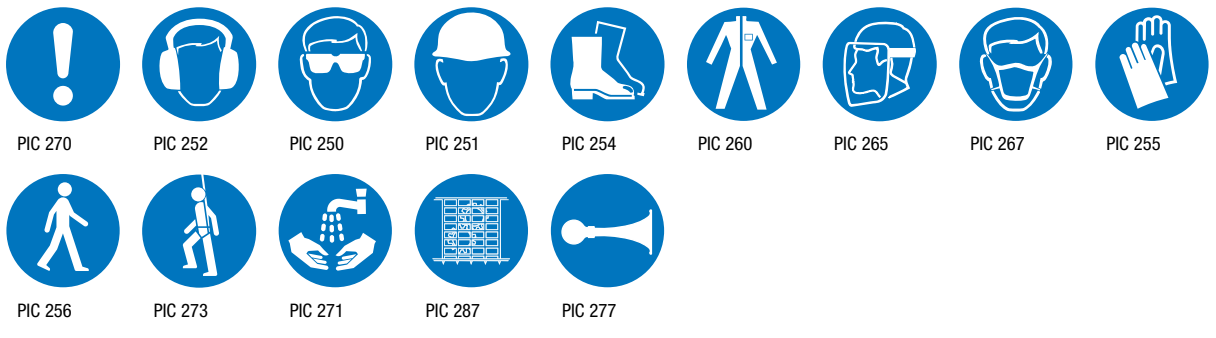
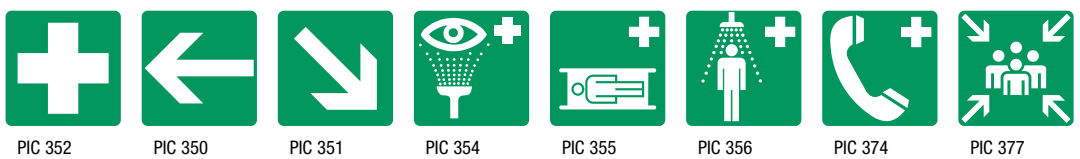

Example

- Part Number: 800047
- Type 1: Warning
Type 2: Prohibition
- Symbol 1: PIC301
Symbol 2: PIC200
- Text 1: Danger Explosion risk
Text 2: Strictly no smoking

Size: 300 x 450 mm
Self-adhesive polyester

Extra Large Safety Signs



BRADY
Customize-it

Contact Brady Customer Service
for more information

- Extra large safety signs are excellent for use when signs need to be read quickly and where a standard sized safety sign could be overlooked.
- A highly visible overhead sign helps employees to achieve higher levels of safe work practices.
- All safety colours are possible with a maximum width of 1.20 m and length of 1.20 m.
- Ask for your personalised signs with your company logo!
- The signs are printed on laminated Polyester and can be stuck to a rigid polypropylene or PVC plate on request.

Safety Sign Examples:

ISOPROPANOL STORAGE
(C₃H₇OH)

No naked flames	Highly flammable	Harmful chemicals
Wear eye protection	Wear gloves	Wear a mask

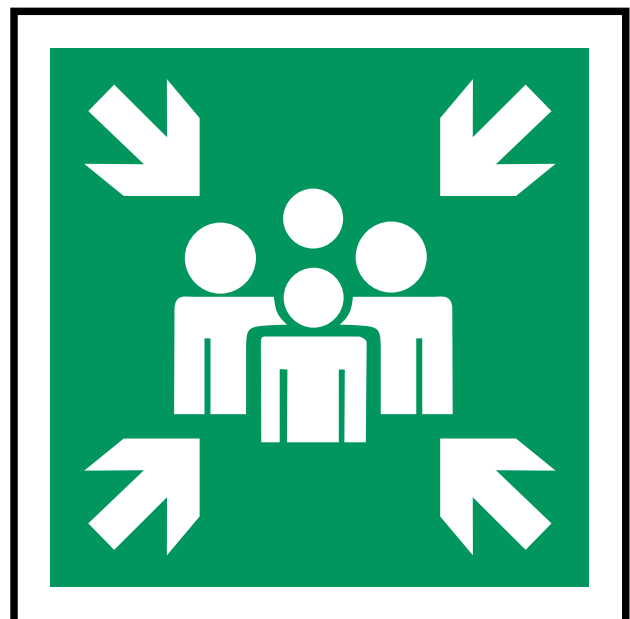



PIPE MARKING

Pipe Marking: Legislation	68	Directional Flow Arrow Tape	78	Maxi-Markers	80
Pipe Marking: An Overview	69	Pipe Banding Tape	78	XXL Pipe Markers	80
European Style Pipe Markers	70	Write-On Markers on Card	78	Pipe Marker Order Form	81
Individual Pipe Markers – on liner	70	Brady Snap-On™	79	Marine Pipe Marking	82
Individual Pipe Markers – linerless	70	Symbols on Rolls (GHS and HSID)	79	Valve Marking	84
Roll form Pipe Markers – on line & linerless	71	10-Year Outdoor Pipe Marker	80		
Pipe Markers – Standard Range	72	Mini-Markers	80		

Pipe Marking: Legislation

Meet the Regulation Standards!

The Health and Safety (Signs & Signals) Regulations 1996 Part 3 require all employers to identify any pipes conveying dangerous substances. Several norms exist across Europe, which indicate how pipes should be identified. Pipes transporting dangerous and hazardous substances must be identified with the relevant danger symbol and the name of the hazardous or dangerous substance.

Safety first!

Unmarked pipes are a danger to both life and property. Accidents, injuries and damage to equipment can be caused by people not knowing what individual pipes contain.

The economical choice!

By correctly identifying pipes, errors can be prevented. Accidents caused by negligence lead to both physical and psychological grief and often cost companies large amounts of money.

Save time!

The correct identification of pipes ensures a better insight into a building's structure – and gaining such an insight with speed and clarity is of vital importance for new employees and temporary staff. It will also make maintenance work easier and prevent time-consuming searches. If an accident does occur, correct identification can help to save valuable time - and even lives.

Safety Awareness Poster

Poster showing an overview of the legal requirements for pipe marking.

Material: 1500 micron styrene

Size: 600 x 400 mm

Order Ref.	Description
701827	Safety awareness poster

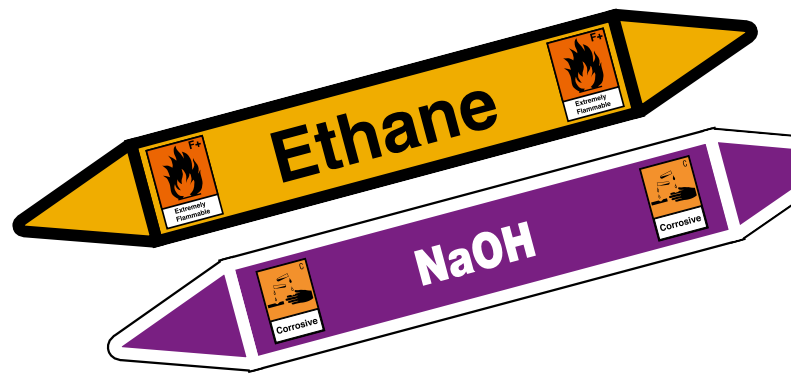

Brady offers you:

A wide range

Over 300 different standard substances are available in several sizes and layouts. This standard range covers the most frequently used industrial substances. In the unlikely event that your particular needs do not appear in this range, don't worry: Brady will customise markers to your personal requirements.

Quality

The self-adhesive markers are made from polyester film, laminated with a crystal clear polyester over-laminate (B-7541). This over-laminate has a very high resistance to chemicals, ultraviolet rays and extreme weather conditions and ensures your pipe marker will stay in place and readable for 5 to 8 years.

i! Brady offers a very high quality material (B-7529) for pipe marking that resists more and 10 year outdoor use. This material can be used in extremely harsh outdoor environments. See page 78 for more information.





Maintenance Tip

- The Signs & Signals Regulations recommend that markers should be mounted on all visible sides of the pipe, the markers should be of durable construction and should be used in conjunction with pictograms where recommended.
- The area that the pipe marker is applied to should be clean, dry and free from grease and dirt
- Where pipes are very dirty or badly corroded - use the Brady Snap-on™, which snaps around the pipe and requires no preparation.

Where to apply pipemarkers?

At frequent intervals on straight pipe runs.

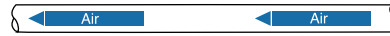

Where pipes pass through floors and walls, mark both sides.

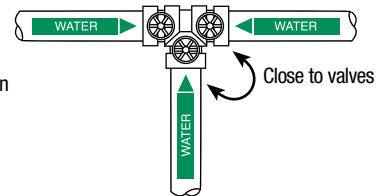
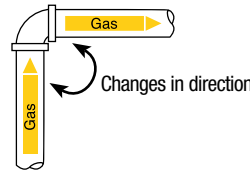
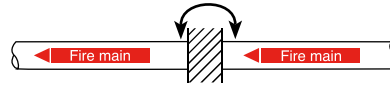

Brady Pipe Marking: An Overview

Layout	Ø Pipe (mm)	Cards or Roll	# Markers	Size	Symbol	For customised markers only	
						Max. # Characters with symbol	without symbol
Type 1 – Individual Markers on liner or linerless							
	25 – 27	card	3	26 mm x 200 mm	with/without	21	29
		roll (linerless)	30				
	40 – 83	card	3	37 mm x 284 mm	with/without	21	29
		roll (linerless)	30	37 mm x 305 mm			
	80 – 115	card	2	52 mm x 402 mm	with/without	21	29
		roll (linerless)	30				
Type 2 – Roll Form Markers on liner or linerless							
	< 70	roll	505	100 mm x 33 m	without	–	36
	< 70	roll	505	127 mm x 33 m	with	32	–
Type 3 – Roll Form Markers on liner or linerless							
	> 70	roll	220	100 mm x 33 m	without	–	36
	> 70	roll	220	127 mm x 33 m	with	32	–
Type 4 – Marine Pipe Markers							
	–	roll	175	127 mm x 33 m	without	–	30
Type 5 – Marine Pipe Markers							
	–	roll	150	225 mm x 15 m	without	–	20
Type 6 – Marine Pipe Markers							
	–	roll	–	225 mm x 15 m	without	–	–
Mini Markers on liner or linerless – customized product							
	6 – 20	card	5	12 mm x 150 mm	with/without	15	17
Maxi Markers on liner or linerless – customized product							
	350	roll	55	225 mm x 15 m	with/without	25	30
	350	roll	120	225 mm x 33 m	with/without	25	30
XXL Markers on liner or linerless – customized product							
	250	piece	1	95 mm x 980 mm	with/without	15	18
Arrow Tape							
	–	roll	1300 arrows	25 mm x 33 m	–	–	–
	–	roll	1300 arrows	50 mm x 33 m	–	–	–
	–	roll	1300 arrows	100 mm x 33 m	–	–	–
Pipe Banding Tape							
	–	roll	–	25 mm x 33 m	–	–	–
	–	roll	–	50 mm x 33 m	–	–	–
	–	roll	–	100 mm x 33 m	–	–	–
Symbols							
	–	roll	500	50 mm x 33 m	–	–	–

European Style Pipe Markers



European Standard Pipe Markers:

- Reinforce safety and aid maintenance.
- Conform to RAL European standard colour coding.
- Chemical symbols conform European Directives 67/548 and 88/379.
- UV-resistant.
- Withstands temperatures from -40°C to +120°C.
- Available in 7 styles and more than 335 legends.

Brady's individual pipe markers

Arrowhead on both ends: simply remove the one not required.

Danger symbol: for dangerous substances the relevant symbol automatically appears on the marker. So you buy and apply just one marker instead of three or four.



Over 300 standard legends

High quality materials: the self-adhesive laminated polyester is resistant to chemicals, ultraviolet rays and extreme weather conditions

Individual Pipe Markers – on liner – type 1

Available in three sizes. Danger and hazard symbols, if relevant and necessary, are automatically printed either side of the text. This saves you having to identify the appropriate symbol. Markers are printed with a contrasting border in the same colour as the text for improved visibility.

Material: laminated polyester (B-7541)

Type 1	Size H x L (mm)	Character height (mm)	Packaging	Pipe diameter (mm)
	26 x 200	12,5	Card (3 markers/card)	25 – 27
	37 x 284	20	Card (3 markers/card)	40 – 83
	52 x 402	25	Card (2 markers/card)	83 – 115

Individual pipe markers – linerless – type 1

Linerless pipe markers offer numerous advantages:

- Fast & easy: just take the pipe marker from the roll and apply it.
- Environmentally friendly: no waste!
- The arrows are perforated, which means you don't need scissors to remove the surplus arrow.
- For dangerous substances the relevant symbol automatically appears on the marker.

Material: laminated polyester (B-7520).

Packaging: 30 markers (3 rolls of 10 or 2 rolls of 15)

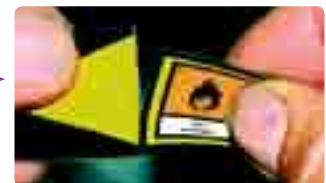

Type 1	Size H x L (mm)	Character height (mm)	Packaging	Pipe Diameter (mm)
	26 x 200	12.5	30 (3 rolls of 10 markers)	25 – 27
	37 x 305	20	30 (3 rolls of 10 markers)	40 – 83
	52 x 402	25	30 (2 rolls of 15 markers)	83 – 115

BRADY
Customize-it

Customized linerless individual pipe markers

- Other text (i.e. substances) can be printed on request.
- Minimum order quantity for sizes 26 x 200 mm and 37 x 305 mm is 3 rolls of 10 markers.
- Minimum order quantity for size 52 x 402 mm is 2 rolls of 15 markers.
- On special request larger rolls can be manufactured. For example rolls with a width of 50, 75, 100 mm etc.

Roll form pipe markers

The design and layout of Brady's roll form markers ensure maximum visibility from all sides. Not only is readability improved by printing the legends in different directions, but also by the different formats available.

These roll form pipe markers are produced in two formats: one for pipes under 70 mm in diameter, and another for pipes over 70 mm in diameter. Both formats come in two widths. For markers without symbols the roll width is 100 mm; with symbols the roll width is 127 mm.

The length of the rolls is always 33 metres.

Roll form pipe markers are available on liner and linerless.



Overlap the ends of your roll form pipe markers for even better adhesion

Roll form pipe markers – type 2: for pipes under 70 mm in diameter

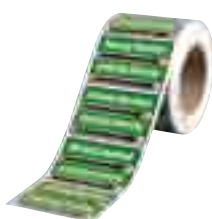

Without danger symbols

Size (mm x m)	Markers per roll	Character height (mm)
100 x 33	505	8

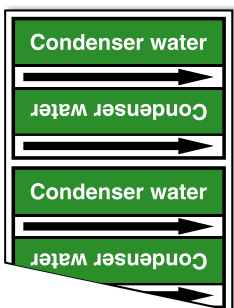

Without danger symbols

Size (mm x m)	Markers per roll	Character height (mm)
100 x 33	220	13



With danger symbols

Size (mm x m)	Markers per roll	Character height (mm)
127 x 33	505	8

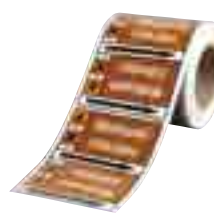
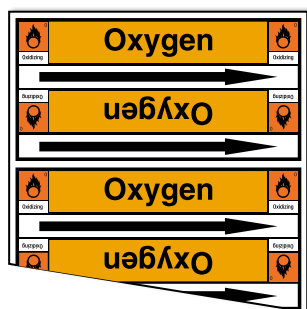

With danger symbols

Size (mm x m)	Markers per roll	Character height (mm)
127 x 33	220	13

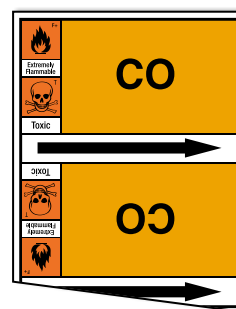

Danger symbols

For dangerous substances the relevant symbol automatically appears on the markers. So you buy and apply just one marker instead of three or four. Below is an overview of the standard danger symbols.



C = Corrosive



T = Toxic



T+ = Very Toxic



F = Highly Flammable



F+ = Extremely Flammable



Xn = Harmful



Xi = Irritant



E = Explosive



O = Oxidizing



N = Hazardous for the environment

European Style Pipe Markers



Roll form pipe markers come in two sizes: 100 mm wide for markers without danger symbols and 127 mm wide for markers with danger symbols. All rolls are 33 metres long.

Pipe markers on liner

Individual pipe markers

Type 1



Roll form pipe markers

Type 2



Type 3



Linerless pipe markers

Individual pipe markers

Type 1



Roll form pipe markers

Type 2



Type 3



Pipe Name	Danger Symbols	Size (mm)			Pipe diameter		Size (mm)			Pipe diameter	
		26 x 200	37 x 284	52 x 402	< 70 mm	> 70 mm	26 x 200	37 x 305	52 x 402	< 70 mm	> 70 mm
Acetylene	F+	228365	228366	228367	228368	228369	224200	224201	224202	224203	224204
Ammonia	T	228370	228371	228372	228373	228374	224205	224206	224207	224208	224209
Argon		228375	228376	228377	228378	228379	224210	224211	224212	224213	224214
Bio Gas		228380	228381	228382	228383	228384	224215	224216	224217	224218	224219
Bio Methane	F+	228385	228386	228387	228388	228389	224200	224221	224222	224223	224224
Butene	F+	228415	228416	228417	228418	228419	224225	224226	224227	224228	224229
Carbon Dioxide		228420	228421	228422	228423	228424	224230	224231	224232	224233	224234
Carbon Monoxide	F+ T	228425	228426	228427	228428	228429	224235	224236	224237	224238	224239
Chlorine	T N	228435	228436	228437	228438	228439	224240	224241	224242	224243	224244
Chloroethane	F+	228440	228441	228442	228443	228444	-	-	-	-	-
Chloromethane	F+ Xn	228445	228446	228447	228448	228449	-	-	-	-	-
CO	F+ T	228455	228456	228457	228458	228459	-	-	-	-	-
CO ₂		228460	228461	228462	228463	228464	224245	224246	224247	224248	224249
Condensate Return		228465	228466	228467	228468	228469	-	-	-	-	-
Condensate		228475	228476	228477	228478	228479	224250	224251	224252	224253	224254
Cooling Gas		228480	228481	228482	228483	228484	-	-	-	-	-
Cyclopropane	F+	228485	228486	228487	228488	228489	-	-	-	-	-
Dimethylamine	F+ Xi	228495	228496	228497	228498	228499	-	-	-	-	-
Drain		228500	228501	228502	228503	228504	224255	224256	224257	224258	224259
Dry Nitrogen Gas		228505	228506	228507	228508	228509	-	-	-	-	-
Ethane	F+	228515	228516	228517	228518	228519	-	-	-	-	-
Ethylene	F+	228520	228521	228522	228523	228524	-	-	-	-	-
Ethylene Oxide	F+ T	228530	228531	228532	228533	228534	-	-	-	-	-
Fluorine	T+ C	228540	228541	228542	228543	228544	-	-	-	-	-
Freon		228545	228546	228547	228548	228549	224260	224261	224262	224263	224264
Freon 21		228555	228556	228557	228558	228559	-	-	-	-	-
Fuel Gas		228560	228561	228562	228563	228564	-	-	-	-	-
Gas		228565	228566	228567	228568	228569	-	-	-	-	-
Gas/Air Mixture		228570	228571	228572	228573	228574	-	-	-	-	-
Heating Gas		228580	228581	228582	228583	228584	-	-	-	-	-
Helium		228585	228586	228587	228588	228589	-	-	-	-	-
Hydrogen	F+	228590	228591	228592	228593	228594	-	-	-	-	-
Hydrogen Chloride	C	228595	228596	228597	228598	228599	-	-	-	-	-
Hydrogen Cyanide	T+	228600	228601	228602	228603	228604	-	-	-	-	-
Hydrogen Sulphide	F+ T+	228605	228606	228607	228608	228609	-	-	-	-	-
Inert Gas		228610	228611	228612	228613	228614	-	-	-	-	-
Isobutane	F+	228615	228616	228617	228618	228619	-	-	-	-	-
Low Pressure Gas		228620	228621	228622	228623	228624	-	-	-	-	-
Methane	F+	228625	228626	228627	228628	228629	-	-	-	-	-
Mixed Gas		228630	228631	228632	228633	228634	-	-	-	-	-
Natural Gas		228635	228636	228637	228638	228639	224265	224266	224267	224268	224269
Nitrogen		228640	228641	228642	228643	228644	224270	224271	224272	224272	224274
Nitrous Oxide		228650	228651	228652	228653	228654	-	-	-	-	-
Oxygen	O	228655	228656	228657	228658	228659	224275	224276	224277	224278	224279
Ozone	T+	228660	228661	228662	228663	228664					
Pentane	F	228665	228666	228667	228668	228669					
Propane	F+	228670	228671	228672	228673	228674					
Propane Gas	F+	228675	228676	228677	228678	228679					





Roll form pipe markers come in two sizes: 100 mm wide for markers without danger symbols and 127 mm wide for markers with danger symbols. All rolls are 33 metres long.

Pipe markers on liner

Individual pipe markers

Type 1



Roll form pipe markers

Type 2



Type 3



Linerless pipe markers

Individual pipe markers

Type 1



	Danger Symbols	Size (mm)			Pipe diameter	
		26 x 200	37 x 284	52 x 402	< 70 mm	> 70 mm
Propene	F+	228680	228681	228682	228683	228684
Pure Gas		228685	228686	228687	228688	228689
Recycled Gas		228690	228691	228692	228693	228694
Return		228695	228696	228697	228698	228699
Sulphur Dioxide	T	228700	228701	228702	228703	228704
Vinyl Bromide	F+	228715	228716	228717	228718	228719
Vinyl Chloride	F+ T	228720	228721	228722	228723	228724

Size (mm)			Pipe diameter	
26 x 200	37 x 305	52 x 402	< 70 mm	> 70 mm
-	-	-	-	-
-	-	-	-	-
-	-	-	-	-
-	-	-	-	-
-	-	-	-	-
-	-	-	-	-
-	-	-	-	-

	Danger Symbols	Size (mm)			Pipe diameter	
		26 x 200	37 x 284	52 x 402	< 70 mm	> 70 mm
Fire Extinguishing		228100	228101	228102	228103	228104
Fire Main		228105	228106	228107	228108	228109
Fire Protection Water		228110	228111	228112	228113	228114
Foam		228115	228116	228117	228118	228119
Sprinklers		228120	228121	228122	228123	228124

Size (mm)			Pipe diameter	
26 x 200	37 x 305	52 x 402	< 70 mm	> 70 mm
224280	224281	224282	224283	224284
224285	224286	224287	224288	224289
224290	224291	224292	224293	224294
224295	224296	224297	224298	224299
224300	224301	224302	224303	224304

	Danger Symbols	Size (mm)			Pipe diameter	
		26 x 200	37 x 284	52 x 402	< 70 mm	> 70 mm
Beer		228125	228126	228127	228128	228129
Detergent		228130	228131	228132	228133	228134
Milk		228135	228136	228137	228138	228139
Radioactive Return		228140	228141	228142	228143	228144
Radioactive Supply		228145	228146	228147	228148	228149
Refrigerated Liquid		228150	228151	228152	228153	228154

Size (mm)			Pipe diameter	
26 x 200	37 x 305	52 x 402	< 70 mm	> 70 mm
-	-	-	-	-
-	-	-	-	-
224750	224751	224752	224753	224754
-	-	-	-	-
-	-	-	-	-
224755	224756	224757	224758	224759

	Danger Symbols	Size (mm)			Pipe diameter	
		26 x 200	37 x 284	52 x 402	< 70 mm	> 70 mm
Air		228155	228156	228157	228158	228159
Breathing Air		228160	228161	228162	228163	228164
Compressed Air		228170	228171	228172	228173	228174
Exhaust		228185	228186	228187	228188	228189
Exhaust Air		228190	228191	228192	228193	228194
High Pressure Air		228195	228196	228197	228198	228199
Hot Air		228200	228201	228202	228203	228204
Instrument Air		228205	228206	228207	228208	228209
Low Pressure Air		228210	228211	228212	228213	228214
Plant Air		228220	228221	228222	228223	228224
Pressurized Air		228225	228226	228227	228228	228229
Return		228235	228236	228237	228238	228239
Sterile Air		228240	228241	228242	228243	228244
Sterile Compressed Air		228245	228246	228247	228248	228249
Vacuum		228265	228266	228267	228268	228269
Vent		228270	228271	228272	228273	228274
Ventilation Air		228275	228276	228277	228278	228279
Wet Air		228280	228281	228282	228283	228284

Size (mm)			Pipe diameter	
26 x 200	37 x 305	52 x 402	< 70 mm	> 70 mm
224305	224306	224307	224308	224309
224310	224311	224312	224313	224314
224315	224316	224317	224318	224319
224320	224321	224322	224323	224324
224325	224326	224327	224328	224329
224330	224331	224332	224333	224334
224335	224336	224337	224338	224339
224340	224341	224342	224343	224344
224345	224346	224347	224348	224349
224350	224351	224352	224353	224354
-	-	-	-	-
224355	224356	224357	224358	224359
-	-	-	-	-
-	-	-	-	-
224360	224361	224362	224363	224364
224365	224366	224367	224368	224369
224370	224371	224372	224373	224374
224375	224376	224377	224378	224379

	Danger Symbols	Size (mm)			Pipe diameter	
		26 x 200	37 x 284	52 x 402	< 70 mm	> 70 mm
Boiler Feed		228725	228726	228727	228728	228729
Brine		228730	228731	228732	228733	228734
Canal Water		228735	228736	228737	228738	228739
Chilled water		228740	228741	228742	228743	228744
Chilled Water Return		228745	228746	228747	228748	228749

Size (mm)			Pipe diameter	
26 x 200	37 x 305	52 x 402	< 70 mm	> 70 mm
-	-	-	-	-
-	-	-	-	-
224380	224381	224382	224383	224384
224385	224386	224387	224388	224389
224390	224391	224392	224393	224394

European Style Pipe Markers



Roll form pipe markers come in two sizes: 100 mm wide for markers without danger symbols and 127 mm wide for markers with danger symbols. All rolls are 33 metres long.

Pipe markers on liner

Individual pipe markers

Type 1



Roll form pipe markers

Type 2



Type 3



Linerless pipe markers

Individual pipe markers

Type 1



Roll form pipe markers

Type 2



Type 3



Water	Danger Symbols	Size (mm)			Pipe diameter	
		26 x 200	37 x 284	52 x 402	< 70 mm	> 70 mm
Chilled Water Supply		228750	228751	228752	228753	228754
Chlorated Water		228755	228756	228757	228758	228759
City Water		228765	228766	228767	228768	228769
Cold Feed		228770	228771	228772	228773	228774
Cold Water Return		228775	228776	228777	228778	228779
Cold Water Supply		228780	228781	228782	228783	228784
Condensate		228785	228786	228787	228788	228789
Condensate Return		228790	228791	228792	228793	228794
Condensate Supply		228795	228796	228797	228798	228799
Condenser Water		228800	228801	228802	228803	228804
Condenser Water Return		228805	228806	228807	228808	228809
Condenser Water Supply		228810	228811	228812	228813	228814
Cooling Circuit		228816	228817	228818	228819	228820
Cooling Water		228821	228822	228823	228824	228825
C. W. S.		228826	228827	228828	228829	228830
Decarbonated Water		228831	228832	228833	228834	228835
Deionized Water		228836	228837	228838	228839	228840
Deminerilised Water		228841	228842	228843	228844	228845
Distilled Water		228846	228847	228848	228849	228850
Domestic Cold Water		228851	228852	228853	228854	228855
Domestic Hot Water Flow		228856	228857	228858	228859	228860
Domestic Water		228861	228862	228863	228864	228865
Drain		228866	228867	228868	228869	228870
Drain Water		228871	228872	228873	228874	228875
Drinking Water		228876	228877	228878	228879	228880
Filtered Water		228881	228882	228883	228884	228885
Fresh Water		228886	228887	228888	228889	228890
Hard Water		228891	228892	228893	228894	228895
Heating		228896	228897	228898	228899	228900
Heating Return		228901	228902	228903	228904	228905
Heating Supply		228906	228907	228908	228909	228910
Heating Water		228911	228912	228913	228914	228915
High Pressure Water		228916	228917	228918	228919	228920
Hot Water		228921	228922	228923	228924	228925
Hot Water Return		228926	228927	228928	228929	228930
Hot Water Supply		228931	228932	228933	228934	228935
Industrial Water		228946	228947	228948	228949	228950
Low Pressure Water		228951	228952	228953	228954	228955
Mains Water		228956	228957	228958	228959	228960
Mineral Water		228966	228967	228968	228969	228970
Non-Drinking Water		228971	228972	228973	228974	228975
Plant Water		228976	228977	228978	228979	228980
Polluted Water		228986	228987	228988	228989	228990
Primary Circuit		228991	228992	228993	228994	228995
Process Water		228996	228997	228998	228999	229000
Pure Water		229001	229002	229003	229004	229005
Purified Water		229006	229007	229008	229009	229010

Size (mm)			Pipe diameter	
26 x 200	37 x 305	52 x 402	< 70 mm	> 70 mm
224395	224396	224397	224398	224399
224400	224401	224402	224403	224404
-	-	-	-	-
224405	224406	224407	224408	224409
224410	224411	224412	224413	224414
224415	224416	224417	224418	224419
224420	224421	224422	224423	224424
224425	224426	224427	224428	224429
224430	224431	224432	224433	224434
-	-	-	-	-
-	-	-	-	-
-	-	-	-	-
-	-	-	-	-
224435	224436	224437	224438	224439
-	-	-	-	-
-	-	-	-	-
224440	224442	224443	224444	224445
-	-	-	-	-
-	-	-	-	-
224445	224446	224447	224448	224449
-	-	-	-	-
224450	224451	224452	224453	224454
-	-	-	-	-
-	-	-	-	-
224455	224456	224457	224458	224459
224460	224461	224462	224463	224464
-	-	-	-	-
-	-	-	-	-
224465	224466	224467	224468	224469
224470	224471	224472	224473	224474
224475	224476	224477	224478	224479
224480	224481	224482	224483	224484
-	-	-	-	-
224485	224486	224487	224488	224489
-	-	-	-	-
224490	224491	224492	224493	224494
-	-	-	-	-
-	-	-	-	-
224495	224496	224497	224498	224499
-	-	-	-	-
-	-	-	-	-





Roll form pipe markers come in two sizes: 100 mm wide for markers without danger symbols and 127 mm wide for markers with danger symbols. All rolls are 33 metres long.

Pipe markers on liner

Individual pipe markers

Type 1



Roll form pipe markers

Type 2



Type 3



Linerless pipe markers

Individual pipe markers

Type 1



Roll form pipe markers

Type 2



Type 3



	Danger Symbols	Size (mm)			Pipe diameter	
		26 x 200	37 x 284	52 x 402	< 70 mm	> 70 mm
Raw Water		229021	229022	229023	229024	229025
Refrigeration		229026	229027	229028	229029	229030
Return		229031	229032	229033	229034	229035
River Water		229036	229037	229038	229039	229040
Roof Drain		229041	229042	229043	229044	229045
Salt Water		229046	229047	229048	229049	229050
Sanitary Drain		229051	229052	229053	229054	229055
Secondary Circuit		229061	229062	229063	229064	229065
Soft Water		229066	229067	229068	229069	229070
Sprinkler Water		229071	229072	229073	229074	229075
Supply		229086	229087	229088	229089	229090
Tank Water		229091	229092	229093	229094	229095
Towns Water		229096	229097	229098	229099	229100
Treated Water		229101	229102	229103	229104	229105
Waste Water		229106	229107	229108	229109	229110
Water		229111	229112	229113	229114	229115
Well Water		229116	229117	229118	229119	229120

	Size (mm)			Pipe diameter	
	26 x 200	37 x 305	52 x 402	< 70 mm	> 70 mm
224500	224501	224502	224503	224504	
-	-	-	-	-	
224505	224506	224507	224508	224509	
-	-	-	-	-	
-	-	-	-	-	
224510	224511	224512	224513	224514	
-	-	-	-	-	
-	-	-	-	-	
224515	224516	224517	224518	224519	
224520	224521	224522	224523	224524	
224525	224526	224527	224528	224529	
224530	224531	224532	224533	224534	
224535	224536	224537	224538	224539	
224540	224541	224542	224543	224544	
224545	224546	224547	224548	224549	
224550	224551	224552	224553	224554	
224555	224556	224557	224558	224559	

	Danger Symbols	Size (mm)			Pipe diameter	
		26 x 200	37 x 284	52 x 402	< 70 mm	> 70 mm
Acetaldehyde	F+ Xn	229121	229122	229123	229124	229125
Acetone	F	229126	229127	229128	229129	229130
Acetonitrile	F T	229131	229132	229133	229134	229135
Acrylonitrile	F T	229141	229142	229143	229144	229145
Alcohol		229151	229152	229153	229154	229155
Allyl Alcohol	T	229156	229157	229158	229159	229160
Benzene	F T	229166	229167	229168	229169	229170
Butanol	Xn	229176	229177	229178	229179	229180
Butanone	F Xi	229181	229182	229183	229184	229185
Chloromethane	F+ Xn	229186	229187	229188	229189	229190
Crude Oil		229191	229192	229193	229194	229195
Cyclohexane	F+	229196	229197	229198	229199	229200
Diesel		229211	229212	229213	229214	229215
Diesel Fuel		229216	229217	229218	229219	229220
Diesel Oil		229221	229222	229223	229224	229225
Emulsion		229226	229227	229228	229229	229230
Ethanol	F	229236	229237	229238	229239	229240
Fat		229241	229242	229243	229244	229245
Formaldehyde	T	229246	229247	229248	229249	229250
Freon		229251	229252	229253	229254	229255
Freon 12		229256	229257	229258	229259	229260
Freon 22		229261	229262	229263	229264	229265
Freon 502		229266	229267	229268	229269	229270
Fuel		229271	229272	229273	229274	229275
Fuel Oil		229276	229277	229278	229279	229280
Fuel Return		229281	229282	229283	229284	229285
Gasoline		229296	229297	229298	229299	229300
Glycol		229301	229302	229303	229304	229305
Heating Oil		229306	229307	229308	229309	229310
Hexane	F Xn N	229311	229312	229313	229314	229315
Hydraulic Oil		229316	229317	229318	229319	229320

	Size (mm)			Pipe diameter	
	26 x 200	37 x 305	52 x 402	< 70 mm	> 70 mm
-	-	-	-	-	
224560	224561	224562	224563	224564	
-	-	-	-	-	
-	-	-	-	-	
-	-	-	-	-	
-	-	-	-	-	
-	-	-	-	-	
-	-	-	-	-	
224565	224566	224567	224568	224569	
-	-	-	-	-	
224570	224571	224572	224573	224574	
224575	224576	224577	224578	224579	
224580	224581	224582	224583	224584	
224585	224586	224587	224588	224589	
224590	224591	224592	224593	224594	
-	-	-	-	-	
-	-	-	-	-	
224595	224596	224597	224598	224599	
-	-	-	-	-	
224600	224601	224602	224603	224604	
224605	224606	224607	224608	224609	
-	-	-	-	-	
-	-	-	-	-	
224610	224611	224612	224613	224614	
224615	224616	224617	224618	224619	
-	-	-	-	-	
224620	224621	224622	224623	224624	

European Style Pipe Markers



Roll form pipe markers come in two sizes: 100 mm wide for markers without danger symbols and 127 mm wide for markers with danger symbols. All rolls are 33 metres long.

Pipe markers on liner

Individual pipe markers

Type 1



Roll form pipe markers

Type 2



Type 3



Linerless pipe markers

Individual pipe markers

Type 1



Roll form pipe markers

Type 2



Type 3



	Danger Symbols	Size (mm)			Pipe diameter	
		26 x 200	37 x 284	52 x 402	< 70 mm	> 70 mm
Hydraulic Power		229321	229322	229323	229324	229325
Hydrogen Peroxide		229326	229327	229328	229329	229330
Kerosene	F+	229336	229337	229338	229339	229340
Lube Oil		229341	229342	229343	229344	229345
Lubricating Oil		229346	229347	229348	229349	229350
Methanol	F T	229351	229352	229353	229354	229355
Methyl Acetate	F	229356	229357	229358	229359	229360
Mineral Oil		229361	229362	229363	229364	229365
Motor Oil		229366	229367	229368	229369	229370
Oil		229381	229382	229383	229384	229385
Paraffin		229386	229387	229388	229389	229390
Pentane	F	229391	229392	229393	229394	229395
Pentanone	F	229396	229397	229398	229399	229400
Petrol		229401	229402	229403	229404	229405
Propanol	F	229406	229407	229408	229409	229410
Propene	F+	229411	229412	229413	229414	229415
Refrigerant 12		229426	229427	229428	229429	229430
Refrigerant 22		229431	229432	229433	229434	229435
Residue		229441	229442	229443	229444	229445
Solvent		229446	229447	229448	229449	229450
Tetrachloroethylene	Xn	229451	229452	229453	229454	229455
Thinner		229456	229457	229458	229459	229460
Toluene	F Xn	229461	229462	229463	229464	229465
Trichloroethane	Xn N	229466	229467	229468	229469	229470
Trichloroethylene	Xn	229471	229472	229473	229474	229475
Unleaded Petrol		229481	229482	229483	229484	229485
Used Solvents		229486	229487	229488	229489	229490
Waste Oil		229491	229492	229493	229494	229495
White Spirit		229496	229497	229498	229499	229500
Xylene	Xn	229501	229502	229503	229504	229505

Size (mm)			Pipe diameter	
26 x 200	37 x 305	52 x 402	< 70 mm	> 70 mm
-	-	-	-	-
-	-	-	-	-
-	-	-	-	-
-	-	-	-	-
224625	224626	224627	224628	224629
-	-	-	-	-
-	-	-	-	-
-	-	-	-	-
-	-	-	-	-
-	-	-	-	-
224630	224631	224632	224633	224634
-	-	-	-	-
-	-	-	-	-
-	-	-	-	-
-	-	-	-	-
-	-	-	-	-
224635	224636	224637	224638	224639
-	-	-	-	-
-	-	-	-	-
-	-	-	-	-
-	-	-	-	-
224640	224641	224642	224643	224644
-	-	-	-	-
-	-	-	-	-

	Danger Symbols	Size (mm)			Pipe diameter	
		26 x 200	37 x 284	52 x 402	< 70 mm	> 70 mm
Exhaust Steam		228285	228286	228287	228288	228289
Feed		228290	228291	228292	228293	228294
High Pressure Steam		228295	228296	228297	228298	228299
H.P. Steam		228300	228301	228302	228303	228304
Industrial Steam		228305	228306	228307	228308	228309
Low Pressure Steam		228310	228311	228312	228313	228314
Medium Pressure		228315	228316	228317	228318	228319
Overheated Steam		228320	228321	228322	228323	228324
Pure Steam		228325	228326	228327	228328	228329
Return		228330	228331	228332	228333	228334
Saturated Steam		228335	228336	228337	228338	228339
Steam		228340	228341	228342	228343	228344
Steam Return		228345	228346	228347	228348	228349
Steam Supply		228350	228351	228352	228353	228354

Size (mm)			Pipe diameter	
26 x 200	37 x 305	52 x 402	< 70 mm	> 70 mm
224645	224646	224647	224648	224649
-	-	-	-	-
224650	224651	224652	224653	224654
-	-	-	-	-
-	-	-	-	-
224655	224656	224657	224658	224659
-	-	-	-	-
-	-	-	-	-
-	-	-	-	-
-	-	-	-	-
224660	224661	224662	224663	224664
224670	224671	224672	224673	224674
224665	224666	224667	224668	224669



Pipe Marking

Directional Flow Arrow Tape

Use Brady arrow tape to emphasise the directional flow of pipe contents. Available in 3 sizes per standard colour.

Length: 33 m

Arrows per roll: ± 1300

Material: Laminated polyester (B-7541)

Width	Size of arrow
25 mm:	20 x 7 mm
50 mm:	40 x 12 mm
100 mm:	80 x 14 mm



Other sizes available on demand



Pipe Banding Tape

By colour coding a pipe you can see at a glance the substance flowing through it. Available in 3 sizes per standard colour

Length: 33 m

Material: Laminated polyester (B-7541)

Yellow/Black Order Ref.	Green/White Order Ref.	Red/White Order Ref.	Blue/White Order Ref.	Orange/Black Order Ref.	Width mm
275100	275101	275102	275103	275104	25
275122	275113	275114	275115	275116	50
275124	275125	275126	275127	275128	100

White/Black Order Ref.	Brown/White Order Ref.	Grey/Black Order Ref.	Violet/White Order Ref.	Black/White Order Ref.	Width mm
275105	275106	275107	275108	275109	25
275117	275118	275119	275120	275121	50
275129	275130	275131	275132	275133	100

Yellow Order Ref.	Green Order Ref.	Red Order Ref.	Blue Order Ref.	Orange Order Ref.	Width mm
275210	275201	275202	275203	275204	25
275222	275213	275214	275215	275216	50
275234	275225	275226	275227	275228	100

White Order Ref.	Brown Order Ref.	Grey Order Ref.	Violet Order Ref.	Black Order Ref.	Width mm
275205	275206	275207	275208	275209	25
275217	275218	275219	275220	275221	50
275229	275230	275231	275232	275233	100



Write-on Markers on card

- Colours following BS 1710.
- Can be written on easily and quickly using a permanent marker (see page 115)

Size: 75 mm x 16 mm

Packaging: 1 card (10 Markers)

Order Ref.	Colour
225358	Yellow
225351	Red
225352	Blue
225353	Green
225354	Black
225355	Brown
225356	Grey
225357	Violet
225358	Ochre

Brady Snap-On™

Brady Snap-On™ is a fast and easy way to mark rusty, wet or oily pipes. The Brady Snap-On™ is a transparent PVC cover on which you can apply any of the markers in our range. The result is that your self-adhesive marker remains readable and well protected

Application

- Apply the self-adhesive marker onto the surface of the Snap-On™.
- Unroll the Snap-On™ so that the marker is positioned in the centre.
- Snap it around the pipe and the Snap-On™ will return to its original shape.

Brady Snap-On™ offers the following advantages:

- Easy to use: simply uncoil and snap around pipe.
- Ideal for identifying rough, wet or oily pipes.
- Great flexibility: Snap-On™ can be used with our full range of self-adhesive markers.
- Perfect for use in extreme cold temperatures.
- Built-in UV protection.
- Ideal for temporary or frequently changing identification.



Order Ref.	Type	Marker size H x L (mm)	Suitable for a pipe diameter of (mm)	Length Snap-On™ (mm)
275240	1	26 x 200	25 - 57	228
275241	2	37 x 284	40 - 83	300
275242	3	52 x 402	83 - 115	420

GHS Symbols on rolls

Using the right symbols when identifying pipes is a legal requirement. To upgrade your current markers to conform to these rules, or to emphasise certain hazards, Brady offers a range of symbols on a roll.

Material: Laminated polyester (B-7541)



Size (W x H) mm	Symbols/Roll	PIC 1801	PIC 1802	PIC 1803	PIC 1804	PIC 1805	PIC 1806	PIC 1807	PIC 1808	PIC 1809
50 x 50	250	811681	811686	811691	811696	811701	811706	811711	811716	811721
100 x 100	250	811679	811684	811689	811694	811699	811704	811709	811714	811719



What is GHS?

GHS – *The Globally Harmonized System of Classification and Labelling of Chemicals* ensures that information on physical hazards and toxicity from chemicals is available in order to enhance the protection of human health and the environment during the handling, transport and use of these chemicals. The GHS also provides a basis for harmonization of rules and regulations on chemicals at national, regional and worldwide level, an important factor also for trade facilitation.

GHS labels will replace the HSID labelling system we use currently. That means that the pictogram on an orange square will be replaced by new symbols with a diamond shape. During the transition period between the publication of the European Directive and the effective date both systems are permitted (HSID and GHS). See www.bradyeurope.com/ghs for more information



HSID Symbols on rolls

Material: Laminated polyester (B-7541)

Number of symbols/roll: 500

Size of label: 46 mm L x 64 mm H



Order Ref.	256990	256991	256992	256993	256994	256995	256996	256997	256998	256999
------------	--------	--------	--------	--------	--------	--------	--------	--------	--------	--------

“Customize-it” Pipe Marking

**BRADY
Customize-it**



10-Year Outdoor Pipe Markers

Brady now offers a very high quality material (B-7529) for pipe marking that resists more than 10 year outdoor use. This material can be used in extremely harsh environments.

Applications

- Refineries
- Oil & Gas rigs
- Chemical plants
- Wherever extended outdoor resistance is needed

How to order?

The pipe markers in this material are available upon request. Please contact BRADY Customer Service for further details.

**BRADY
Customize-it**



Mini Markers

The Mini Marker (12 x 150 mm) has been specially developed by Brady for the identification of small pipes in laboratories and hospitals. These markers, made from a thin, flexible polyester (B-7548), are available on request. They are sold by the card, with five markers per card. For technical reasons the full name of the substance cannot be printed when the marker requires danger symbols.

For pipes with a diameter from 6 to 20 mm.

Quantity per card	Size H x W	Letter height	Max. # characters	
			with symbols	without symbols
5 pcs	12 x 150 mm	6.5 mm	15	17

**BRADY
Customize-it**



Maxi Markers

The Maxi Markers (225 mm wide) are ideal for pipes over 350 mm in diameter. The markers are made from laminated polyester (B-7541)

Quantity on roll	Size H x W	Letter height	Max. # characters	
			with symbols	without symbols
55 pcs.	225 mm x 15 m	19 mm	25	30
120 pcs.	225 mm x 33 m	19 mm	25	30



Maxi Markers are also available in linerless laminated polyester (B-7520) on request

**BRADY
Customize-it**



XXL Pipe Markers

These giant pipe markers allow you to see at a glance all the necessary information about the fluid or gas running through a pipe. They are ideal for marking pipes that can only be viewed from a greater distance or that are too high up for smaller markers to be effective.

Size: 980 mm x 95 mm

Maximum # characters: 15 with symbols / 18 without symbols

Character height: 55 mm

Material: Laminated polyester (B-7541)



Minimum order quantity: 1 marker

Brady "Customize-it" Pipe Marker order form

BRADY
Customize-it

- 1 Select **Marker Type**.
- 2 State **Quantity** Required.
- 3 Write in the "**Legend**" box the text to be printed.
- 4 Fax **Brady Customer Service** with this order form and your contact information (name, address, delivery address, phone, fax,e-mail).

Individual Markers with Die-Cut Arrows

Type	Description	Letter height (mm)	Max. number of letters		Packaging	Quantity	Legend
			Without symbols	With symbols			
	26 x 200 mm on liner	12,5	29	21	3 markers on card	<input type="text"/>	<input type="text"/>
	26 x 200 mm linerless	12,5	29	21	3 rolls of 10 markers	<input type="text"/>	<input type="text"/>
	37 x 284 mm on liner	20	29	21	3 markers on card	<input type="text"/>	<input type="text"/>
	37 x 305 mm linerless	20	29	21	3 rolls of 10 markers	<input type="text"/>	<input type="text"/>
	52 x 402 mm on liner	25	29	21	2 markers on card	<input type="text"/>	<input type="text"/>
	52 x 402 mm linerless	25	29	21	2 rolls of 15 markers	<input type="text"/>	<input type="text"/>

Mini-Markers

Description	Letter height (mm)	Max. number of letters		Packaging	Quantity	Legend
		Without symbols	With symbols			
 12 x 150 mm on liner	6,5	17	15	5 markers on card	<input type="text"/>	<input type="text"/>

Maxi-Markers (pipe diameter > 350 mm)

Description	Letter height (mm)	Max. number of letters		Packaging	Quantity	Legend	
		Without symbols	With symbols				
	225 mm x 15 m on liner	19	13*	11*	Roll of 55 markers	<input type="text"/>	<input type="text"/>
		30	30	25	Roll of 55 markers	<input type="text"/>	<input type="text"/>
225 mm x 15 m linerless	19	30	30	25	Roll of 55 markers	<input type="text"/>	<input type="text"/>
		225 mm x 33 m on liner	6,5	30	25	Roll of 120 markers	<input type="text"/>
225 mm x 33 m linerless	6,5	30	30	25	Roll of 120 markers	<input type="text"/>	<input type="text"/>

*number of letters per line, maximum 3 lines

XXL Pipe Markers

Description	Letter height (mm)	Max. number of letters		Packaging	Quantity	Legend
		Without symbols	With symbols			
 980mm x 95 mm	50	18	15	Piece	<input type="text"/>	<input type="text"/>

Roll Form Markers (pipe diameter < 70 mm)



Description	Letter height (mm)	Max. number of letters	Packaging	Quantity	Legend
100 mm x 33 m linerless (without danger symbols)	8	36	Roll of 505 markers	<input type="text"/>	<input type="text"/>
127 mm x 33 m on liner (with danger symbols)	8	32	Roll of 505 markers	<input type="text"/>	<input type="text"/>
127 mm x 33 m linerless (with danger symbols)	8	32	Roll of 505 markers	<input type="text"/>	<input type="text"/>

Roll Form Markers (pipe diameter > 70 mm)



Description	Letter height (mm)	Max. number of letters	Packaging	Quantity	Legend
100 mm x 33 m linerless (without danger symbols)	13	36	Roll of 220 markers	<input type="text"/>	<input type="text"/>
127 mm x 33 m on liner (with danger symbols)	13	32	Roll of 220 markers	<input type="text"/>	<input type="text"/>
127 mm x 33 m linerless (with danger symbols)	13	32	Roll of 220 markers	<input type="text"/>	<input type="text"/>

PIPE MARKING

Marine Pipe Marking



Marking pipes on ships and offshore sites is of the utmost importance to insure safety at all times. Accidents, injuries and damage to machines and equipment can be caused by people's ignorance of the substances that flow through pipes.

The ISO 14726 standard (International Standard Organization), specifies the principle colours for the identification of substances in pipes.

ISO (DIS)14726-2 specifies additional colour codes that allow a more detailed identification of the substance.



Pipes must be marked in the following manner:

- At least once in every room.
- At each point where the pipes pass through a wall, a ceiling or floor.
- In close proximity of each valve.
- Every 3 to 5 metres (sometimes the local authorities will demand additional markers).
- Arrows to indicate the directional flow are advisable
- Additional identification by usage of text will avoid any confusion regarding the content of the pipes.

Brady offers you several marine pipe marking solutions:

Pipe Banding Tape in principle colours

1 Single Colour

Sizes: 100 mm x 33 m – 50 mm x 33 m – 25 mm x 33 m

Layout: pipe banding tape in ONE colour, no Text

Material: B-7541

Order Ref.: see page 78



2 Two Colours – type 6

Size: 225 mm x 15 m

Layout: 7 – pipe banding tapes in TWO colours, no text

Material: B-7541

Order Ref.: see next page for standard range



Pipe Markers with text:

These markers in addition to primary and possibly secondary colours, indicate the directional flow of a substance, as well as its name. All this together forms a complete identification! The markers are available as roll form pipe markers in 2 versions:

1 Roll form marker with text and directional flow arrow – type 4

Size: 127 mm x 33 m

Layout: 5 – text and directional flow arrow underneath the colours

Material: B-7541

Order Ref.: see next page for standard range

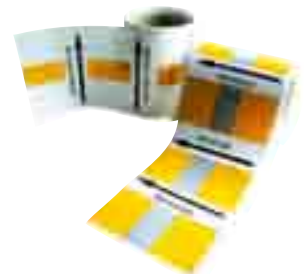

2 Roll form marker with text and directional flow arrow – type 3

Sizes: 225 mm x 15 m

Layout: 6 – one half colour coding and one half text with directional flow arrow

Material: B-7541

Order Ref.: see next page for standard range



All you need to place an order is the part number (which you can find on the next page) and the number of rolls required



The ISO 14726 standard defines the principle colours for identifying pipes. Each of the following colours indicates a certain group of substances. As this is an international standard and most ships sail in international waters, all text is in English only.

Group colour	Substance	Group colour	Substance
Black	Waste Media	Orange	Oils other than fuel
Blue	Fresh Water	Silver	Steam
Brown	Fuel	Red	Fire Fighting
Green	Sea Water	Violet	Acids, Alkalis
Grey	Non-flammable gases	White	Air in ventilation systems
Copper	Masses (dry and wet)	Yellow	Flammable gases

Legend	Colours	Type 4	Type 5	Type 6
		127 x 33 Order Ref.	Size (mm x m) 225 x 15 Order Ref.	225 x 15 Order Ref.

Legend	Colours	Type 4	Type 5	Type 6
		127 x 33 Order Ref.	Size in mm 225 x 15 Order Ref.	225 x 15 Order Ref.

Waste Media				
Waste Media		226990	227051	227170
Black Water		226991	227052	227171
Waste Oil		226992	227053	227172
Bilge Water		226993	227054	227173
Exhaust gas		226994	227055	227174
Sewage		226995	227056	227175

Fresh Water				
Fresh Water		226996	227057	227176
Condensate from heating system		226997	227058	227177
Fresh water-sanitary		226998	227059	227178
Cooling fresh water		226999	227060	227179
Feed water		227000	227061	227180
Distillate		227001	227062	227181
Potable water		227002	227063	227182
Chilled water		227003	227064	227183
Condensate		227004	227065	227184

Fuel				
Fuel		227005	227006	227185
Heavy Fuel		227006	227067	227186
Liquid gas		227007	227068	227187
Petrol		227008	227069	227188
Diesel Fuel		227009	227070	227189

Sea water				
Sea water		227010	227071	227190
Ballast water		227011	227072	227191
Cooling sea water		227012	227073	227192
Sanitary sea water		227013	227074	227193

Non-flammable gases				
Non-flammable gases		227014	227075	227194
Oxygen		227015	227076	227195
Breathing gas		227016	227077	227196
Nitrogen		227017	227078	227197
Refrigerant		227018	227079	227198
Pressure air HP		227019	227080	227199
Breathing air		227020	227081	227200

Masses				
Masses		227167	227168	227169

Oil other than fuel				
Oil other than fuel		227021	227082	227201
Used oil		227022	227083	227202
Thermal oil		227023	227084	227203
Dirty oil		227024	227085	227204
Lubricating oil		227025	227086	227205
Hydraulic oil		227026	227087	227206

Steam				
Steam		227027	227088	227207
Steam for heating		227028	227089	227208
Bleeder steam		227029	227090	227209
LP Drains		227030	227091	227210
Supply steam		227031	227092	227211
Exhaust steam		227032	227093	227212
HP Drains		227033	227094	227213

Fire fighting				
Fire fighting		227034	227095	227214
Fire-fighting fresh water		227035	227096	227215
Fire-fighting sea water		227036	227097	227216
Fire-fighting CO2 gas		227037	227098	227217
Sprinkler water		227038	227099	227218
Fire-fighting powder		227039	227100	227219
Fire-fighting foam		227040	227101	227220

Acids & Alkalis				
Acids & Alkalis		227041	227102	227221

Air in ventilation systems				
Air in ventilations systems		227042	227103	227222
Natural exhaust air		227043	227104	227223
Supply air, atmospheric		227044	227105	227224
Natural supply air		227045	227106	227225
Mechanical exhaust air		227046	227107	227226

Flammable gases				
Flammable gases		227047	227108	227227
Hydrogen		227048	227109	227228
Acetylene		227049	227110	227229
Mixture of Propane/Butane		227050	227111	227230

Valve Marking



For a professional and uniform identification of the substances conveyed by pipes and running through valves. BRADY offers a wide range of identification tags from stock or custom made to your specifications



Brass Identification Tags for Valves, embossed with number sequences

Round tags which have been pre-marked with black numbers, grouped in number sequences.

Size: tag diameter: 38 mm / hole diameter: 5 mm

Packaging: 25 tags

Sequence	1-25	26-50	51-75	76-100	101-125	126-150	151-175	176-200	201-225	226-250
Order Ref.	023200	023201	023202	023203	023204	023205	023206	023207	023208	023209
Sequence	251-275	276-300	301-325	326-350	351-375	376-400	401-425	426-450	451-475	476-500
Order Ref.	023617	023618	023619	023620	023621	023622	023623	023624	023625	023626



Blank Identification Tags

Make your own tags whenever you need them. Blank tags which you can engrave yourself, available in brass, aluminium, copper or stainless steel.

- Sizes:**
- Round (ø 38 or 51 mm)
 - Square (side 38 or 51 mm)

Hole: ø 5 mm

Packaging: 25 tags

Order Ref.	Material	Max. T°	Shape	Size
227112	Brass	648°C	Round	38 mm
227113			Round	51 mm
227114			Square	38 mm
227115			Square	51 mm
227116	Aluminium	815°C	Round	38 mm
227117			Squar	51 mm
227118	Stainless Steel	1482°C	Round	38 mm
227119			Square	51 mm
023210	Copper		Round	38 mm
023211			Round	51 mm
023212			Square	38 mm
023213			Square	51 mm

BRADY
Customize-it



Sizes
Round – Diameter 38 mm or 51 mm
Square – Side 38 mm or 51 mm
Triangular – Side 38 mm or 51 mm
Octagonal – Diameter 51 mm
Hexagonal – Diameter 38 mm

“Customize-it” Brass Identification Tags

With embossed text and sequential numbering

- **Round, square, octagonal and hexagonal:**
Max. 6 letters and 4 numbers.
- **Triangular:**
 - 38 mm: max. 3 letters and 3 numbers,
 - 51 mm: max. 4 letters and 4 numbers.
- Height numbers: 12 mm – height letters: 6 mm.
- The embossed characters can be left natural or coloured black.
- 1 line of letters and 1 line of numbers

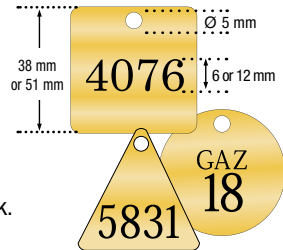

Colours		
GR	BU	BK
WH	RD	BN
YL	OR	

Bradyply

Engraved valve tags: maintenance free valve marking

High quality material for engraving. Max. 3 lines can be engraved per tag (8 characters per line). Tags are engraved on one side only. Withstands temperatures up to 65°C.

BRADY
Customize-it

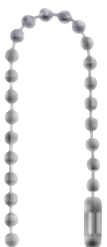

Beaded Chain

With locking link. Suitable for numerous applications.

Length: 114 mm

Packaging: 100 pieces

Order Ref.	Material
227120	Nickel plate
227121	Brass Jack



Attachment chain in copper, brass or zinc

The length of the chain can be adjusted by opening and closing links. ± 80 links per metre. Approximately 250 mm is enough to fasten 1 tag.

Order Ref.	Material	Packaging
227122	Brass	10 m
227123	Zinc	10 m
023308	Copper	15 m



Metal Clips

For fast and easy application of your identification and valve tags. Galvanised steel, opens and closes by pushing the open ends away from each other and releasing them.

Inner diameter: 35 mm.

Packaging: 100 pieces

Order Ref.
227130



Stainless Steel “S” – Hooks

Very resistant, designed for extreme conditions, up to 1480°C. Good usage in food industry etc.

Diameter: 2 mm

Packaging: 100 pieces

Order Ref.	Sizes
227127	32 mm
227128	38 mm
227129	44 mm



Brass “S” Hooks

Resistant to chemicals, inside and outside use up to 648°C.

Diameter: 2 mm

Packaging: 100 pieces

Order Ref.	Sizes
227124	32 mm
227125	38 mm
227126	44 mm



LOCKOUT TAGOUT

What, How & Legislation	86
Product Groups	88
Lockout Selection Tool	89
Mechanical Risk	
Universal	90
Ball Valves	91
Gate Valves	92
Cable Lockout Devices	93
Butterfly Valves	95
Gas Cylinder Lockouts	96
Pneumatic Lockouts	96

Electrical Risk	
Plug Lockouts	97
Circuit Breaker Lockouts	98
Miniature Circuit Breaker Lockout	100
Lockout kits	
Ultimate lockout kit	101
Valve and electrical lockout kit	102
Valve lockout kit	102
Electrical lockout kit	102
Small adjustable lockout kit	103
Lockout starter kit	103
Gate valve lockout kit	103
Mini lockout starter kit	103

Padlocks, Hasps & Accessories	
Padlocks	104-107
Hasps & Accessories	108
Lockout Stations	110
Lock Boxes	112
Padlock Centres	112
Lockout Pouches	113
Tagout	
Tags	114
Tag Holder	117
Magnetic identification	117
Custom Tags	118

What, How & Legislation



Every year thousands of workers get killed or injured while performing repairs or maintenance on industrial equipment or machinery. Many of these accidents are caused by the uncontrolled release of energy. In Europe however, several regulations exist, requiring that all energy sources are turned off and 'locked out' while machines are being serviced or repaired.



What is it?

Lockout Tagout is a planned safety procedure which involves turning off the energy supply of industrial machinery and equipment whilst maintenance work or repairs are being carried out. This procedure protects workers from the risks posed by live machinery or electricity.

Why Lockout/Tagout?

- Safe working while doing maintenance, cleaning or repairs.
- Prevention of injuries
- Prevention of damage
- It helps to prevent errors being made.
- It is a procedure which clearly communicates risk in the workplace

When you neglect Lockout Tagout you neglect people.

Current Legal Requirements

- In the UK the Provision of Work Equipment Regulations – Regulation 19 – Isolation from Sources of energy states: "Every employer shall ensure, that where appropriate, work equipment is provided with suitable means to isolate it from all its sources of energy. Every employer shall take appropriate measures to ensure that reconnection of any energy source to work equipment does not expose any person using the equipment to any risk to his health or safety".
- The EU Guidelines 89/655 specify the minimum requirements concerning safety and health while using equipment. Paragraph 2.14 lays down that "every piece of equipment must be fitted with clearly visible devices with which it can be separated from every energy source.

OSHA Regulations (USA)

OSHA regulation The Control of Hazardous Energy (Lockout / Tagout) 1910.147 states that it "requires employers to establish a program and utilise procedures for affixing appropriate lockout devices or tagout devices to energy isolating devices and to otherwise disable machines or equipment to prevent unexpected energisation, start up or release of stored energy in order to prevent injury to employees."

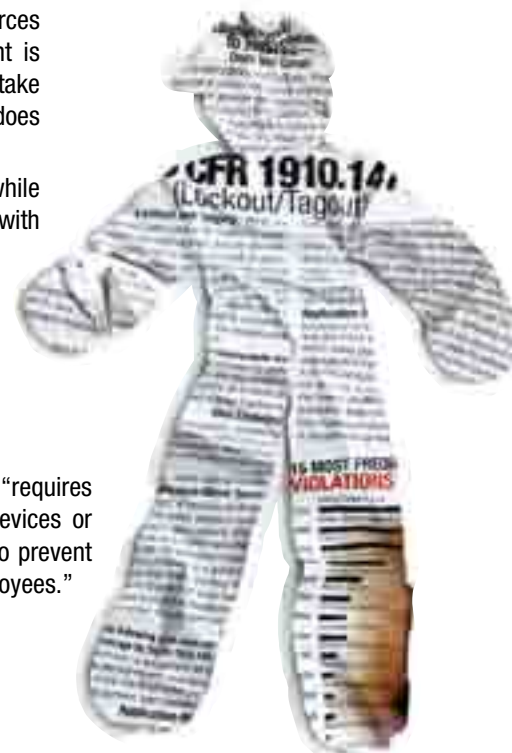



Lockout/Tagout training DVD

Comply with regulations - provide safety training to every member of staff. Ensuring that all relevant members of staff receive safety training reduces both the risk of accidents occurring in the workplace and their associated costs.

Lockout/Tagout: 9 Basic Steps

An ideal tool for all Safety Managers this handy DVD helps to explain the simple safety procedure of Lockout/Tagout by focussing on the basic steps that must be followed.

- What Lockout/Tagout is and when to perform it
- Six steps in controlling hazardous energy
- Three steps for a safe restoration of energy

Duration: 14 minutes

Order Ref.
805854

Lockout For Life

Learn from other workers' tragic mistakes.

This motivational video presents six real-life dramatizations of actual industrial accidents due to poor lockout procedures and analyzes how they could have been prevented

- Suitable for new and experienced employees

Duration: 19 minutes

Order Ref.
805855

Establishing a good Lockout/Tagout programme requires 3 basic steps:



1

Develop a Written Program

This involves identifying and writing procedures for the control of hazardous energy. This also includes preparation for shutdown, equipment isolation, Lockout/Tagout application, release of stored energy and verification of energy isolation to each piece of equipment.



2

Training Employees

Both affected and authorised employees must be trained in the specific energy control procedures established by the company. Verification of this training is required.



3

Implement the Program

In addition to developing format written procedures and training employees, Brady offers a variety of padlocks, tags, signs and lockout devices to help you implement lockout procedures for many different energy sources, including: electricity, pneumatics, steam, gas, liquids and many others.

7 Steps to good Lockout/Tagout implementation

Step 1: Preparation

Prepare for a shut down of energy source. Identify type of energy used (e.g. electrical or mechanical) and its potential hazards. Locate the isolator(s) and prepare to "lock off" energy source.

Step 2: Notification

Inform operators and supervisors who may be affected by isolating the machinery and inform them of the work being undertaken.

Step 3: Shut-down

Turn off the equipment or machine.

Step 4: Lock Off

Lock off all energy sources using the proper Brady lockout devices to de-energise the equipment or machinery. Apply a lock so no one can turn the switch or valve whilst the work is being undertaken. Warn against accidental use by attaching Brady lockout warning tags.

Step 5: Test

Test all machine controls and electrical circuits to ensure energy is completely isolated.

Step 6: Repair or rework

Perform maintenance and or servicing.

Step 7: Return to service

When all work is done and lockout/tagout devices are removed, be sure to test and look to ensure all tools and mechanical and electrical lockout devices have been removed. Before re-energising be sure to warn all workers.



Product Groups

Lockout: Devices for risk prevention

Mechanical Risk

Universal Risks	90
Lockout for valves in all positions	90
Ball Valve Lockout Devices	91
Lockouts for valves in closed position	91
Lockout for valves in open & closed position	91
Gate Valve Lockout devices	92
Adjustable Gate Valve Lockout	92
Standard Gate Valve Lockout	92
Cable Lockouts	93
All Purpose Lockout	93
Mini Cable Lockout	93
Universal Valve Lockout	93
Brady Cable Lockout	94
Scissor Lok™	94
Pro Lock II®	94
Butterfly Valve Lockout	95
Cylinder Lockouts	96
Cylinder Tank Lockout	96
Gas Cylinder Lockout	96
Pneumatic Lockouts	96

Electrical Risk

Plug Lockouts	97
Electrical/Pneumatic Plug Lockout	97
Lockout for Plug Connections	97
Hubbell Plugout	97
Circuit Breaker Lockouts	98
Universal Multi-Pole Breaker Lockout	98
Economy Multi-Pole Breaker Lockout	98
Single Pole Breaker Lockout	98
"No Hole" Circuit Breaker Lockout	98
Oversized Breaker Lockout	99
480-600V Breaker Blocker	99
Miniature Circuit Breaker Lockouts	100

Lockout Kits

Ultimate lockout kit	101
Valve and electrical lockout kit	102
Valve lockout kit	102
Electrical lockout kit	102
Small adjustable lockout kit	103
Lockout starter kit	103
Gate valve lockout kit	103

Locks, Hasps & Accessories

Padlocks	105
Non-Conductive Lockouts	108
Nylon Lockout Hasp	108
Safety Lockouts	108
Mini Lockout Starter Kit	108
Economy Lockout	109
Stubby Lockout	109
Heavy Duty Steel Lockout	109
Labelled Safety Lockout Hasps	109
Blank Safety Lockout Hasps	109
Lockout Stations & Lock Boxes	110
Lock Boards	110
Adjustable Lockout Stations	111
Industrial Strength Lockout Station	111
Group Lock Box	112
Group Lockout Centre	112
Padlock Control Centre	112
Padlock Station	112
Lockout Pouches & Bags	113

LOCKOUT TAGOUT



Tagout: Communication of risks

Maintenance & Quality Control Tags	114
Machine Safety	114
Warning & Safety Tags	115
Tag Holders	117
Coloured Nylon Ties	117
Magnetic Signs	117
Pouches with Magnetics Strips and Loops	117





Type of Risk	Application	Blocking		Device	Page	
		Type	Position			
MECHANICAL RISKS	Ball Valve	Fixed	Closed	Brady Ball Valve Lockout	91	
			Closed	Non-Conductive Ball Valve Lockout	91	
			Open/Closed	Prinzing Ball Valve Lockout	91	
		Adjustable	Open/Closed	Universal Valve Lockout	90	
	Gate Valve	Adjustable	All types		Standard Gate Valve Lockout	92
					Adjustable Gate Valve Lockout	92
					Mini Cable Lockout	93
					Scissor-Lok™	94
					Brady Cable Lockout	94
					Pro Lock II®	94
	Butterfly Valves	Adjustable	All types		Butterfly Valve Lockout	95
					Universal Valve Lockout	90
	Gas Cylinder	Adjustable	All types		Cylinder Tank Lockout	96
					Gas Cylinder Lockout	96
	Pneumatic Plugs	Fixed	No operation		Pneumatic Lockout	96
				Electrical / Pneumatic Lockout	97	



Type of Risk	Application	Device	Page	
ELECTRICAL RISK	Electrical Plugs	Electrical / Pneumatic Lockout	97	
		Electrical Plug Lockout	97	
		Industrial Electrical Plug Lockout	97	
	Panels		Mini Cable Lockout	93
			Scissor-Lok™	94
			Brady Cable Lockout	94
			Pro Lock II®	94
			All Purpose Cable Lockout	93
			Non-Conductive Lockout Hasp	108
			Nylon Lockout Hasp	108
	Breakers		Miniature Circuit Breaker Lockout	100
			Universal Multi-Pole Breaker Lockout	98
			Economy Multi-Pole Breaker Lockout	98
			Single Pole Breaker Lockout	98
			"No Hole" Circuit Breaker Lockout	98
	480-600V Breaker Blocker	99		



You will find the lock icon as displayed on the left, throughout the Lockout/Tagout section of this catalogue. It indicates information that will help you choose the right lock to use with our Lockout devices.

Mechanical Risk – Universal

Universal Valve Lockout: One device does it all!

The Universal Lockout device is a modular system which enables you to lock out valves of different types and sizes. No other device offers such flexibility and security. There are two sizes available: large and small.

- Modular system makes your investment economical and flexible
- Can be used to lock out large levers, T-handles and other hard-to-secure mechanical devices
- New open-ended clamp fits over closed rings, wide handles
- Locks out valves in **open and closed positions**
- Made from industrial-grade steel and nylon for rugged durability, chemical and corrosion resistance



- **Max. shackle diameter:** 9 mm
- **Min. shackle clearance:** 20 mm

Base clamping unit →



Order Ref.	Description
050924	Small Universal Valve Lockout Base Clamping Unit
050899	Large Universal Valve Lockout Base Clamping Unit
065402	Small Blocking Arm
065403	Large Blocking Arm
051395	Cable attachment with 2.44 metre sheathed cable Cable diameter 3.25 mm

Maximum valve handle width	
Small Lockout: 25 mm	Large Lockout: 41 mm

Maximum handle thickness	
Small Lockout: 19 mm	Large Lockout: 31.75 mm

The Universal Lockout is a modular construction where the user can add various accessories to make the device suitable for a range of valves. Simply disassemble the device (as shown in picture) and slot in the relevant accessory.



Optional blocking arm(s) can be added to make device suitable for ball valves in half-open, open or partially open positions.

Cable attachment can be added to make device suitable for locking off gate valves

LOCKOUT TAGOUT



Clamp attaches to butterfly valve lever, preventing trigger handle from being squeezed. Valve cannot be repositioned!



Use blocking arm to lock out quarter-turn ball valves



Use cable attachment to lock out gate valves



Use two blocking arms to lock out 3-, 4- or 5-way valves, or to lock valves in the throttled position for operational control

Lockouts for valves in **closed position**

Brady Ball Valve Lockout

- Locks quarter-turn ball valves in OFF position
- Fits virtually any valve lever up to 76 mm
- Very compact and lightweight solution
- Available in 2 sizes
- **Packaging:** 1 piece

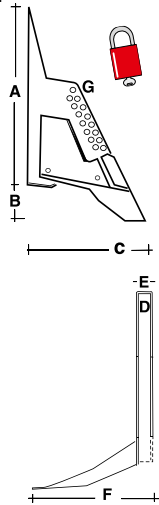

Order Ref.	Size valve lever	Minimum shackle clearance	Material
065666	6 - 25 mm	25 mm	Nylon
065692	6 - 25 mm	19 mm	Steel
065669	32 - 76 mm	19 mm	Steel
065693	32 - 76 mm	19 mm	Steel

Order Ref.	A mm	B mm	C mm	D mm	E mm	F mm	G pieces	G Ø
065666	80	30	60	8	12	71	8	7.5
065692	87	30	50	8	11	63	6	10
065669	150	30	110	10	15	110	15	7.5
065693	150	30	110	10	15	110	7	10



Non-Conductive Ball Valve Lockout

- Non-conductive
- Intuitive and easy to place
- Locks quarter-turn ball valves in OFF position
- Made from strong polypropylene plastic, resistant to cracking, abrasion and chemical products
- Resistant to extreme temperature changes -46 to 183°C
- **Max. shackle diameter:** 7 mm
- **Min shackle clearance:** 20 mm
- **Packaging:** 1 piece

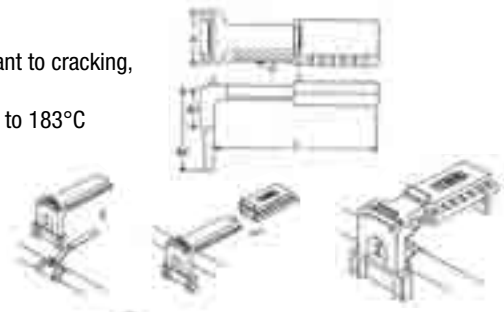

Order Ref.	Width (A)	Height (B)	Length of lever (C)	Lock hole (D)
225340	95 mm	125 mm	190 to 250 mm	8 mm

Lockout for valves in **open & closed position**



Ball Valve Lockout

- Small device locks out pipes from **12.5 to 31 mm** in **open and closed** position
- Large device locks out pipes from **50 to 200 mm** in **closed** position
- Versatile and easy to use
- The two halves of the device encompass the ball valve lever to secure it from inadvertent activation of the valve
- Made from ultra-tough polypropylene
- **Max. shackle diameter:** 6.5 mm
- **Min. shackle clearance:** 38 mm
- **Packaging:** 1 piece



Order Ref.	Order Ref.	Order Ref.	Order Ref.	Type
Red	Blue	Green	Yellow	
800110	805847	805848	805849	Small
800111	805850	805851	805852	Large



See page 92 for tips on how to use different colours

Mechanical Risk – Gate Valves



Adjustable Gate Valve Lockout

- Adjusts to fit gate valves from **2.5 to 16.5 cm**
- **One device for most gate valves**
- Replaces 3 conventional gate valve lockouts = reduced costs
- Durable polypropylene
- Resistant to extreme temperature changes from -45°C to 182°C
- **Max. shackle diameter:** 7 mm
- **Min. shackle clearance:** 20 mm
- **Packaging:** 1 piece



Order Ref.
064057



Standard Gate Valve Lockout

- Locks out gate valves from **2.5 to 32 cm**
- Made of durable polypropylene – superior impact & chemical resistance
- Withstands temperatures from -30°C to 150°C
- Available in 5 sizes and 4 colours
- Comes with danger labels in English, Spanish and French
- **Max. shackle diameter:** 6.5 mm
- **Min. shackle clearance:** 38 mm
- **Recommended lock:** - Safety Packlock (page 105)
- Safety Lockout (page 108)
- **Packaging:** 1 piece



Hand wheel diameter (mm)	Order Ref. Red	Order Ref. Yellow	Order Ref. Green	Order Ref. Blue
25 - 64	065560	065590	065595	065585
64 - 127	065561	065591	065596	065586
127 - 165	065562	065592	065597	065587
165 - 254	065563	065593	065598	065588
254 - 320	065564	065594	065599	065589

320 and larger (see cable lockout devices)

Hand wheel diameter (mm)	Dimensions (mm)						
	A	B	C	D	E	F	G
25 - 64	75	20	-	19	69	33	39
64 - 127	140	20	30	42	130	36	46
127 - 165	170	20	51	63	167	43	53
165 - 254	270	20	70	90	260	63	70
254 - 320	350	25	75	100	340	70	80



Unique knockout feature: can be removed by hand to accommodate "rising stem" gate valves

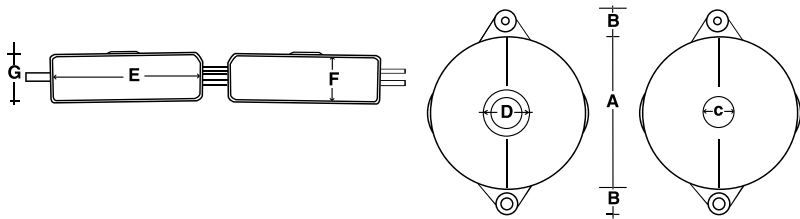

Why use different colours?

- **Valves in open or closed position:** red = open, green = closed
- **Indicate risk levels:** red = high risk, blue = low risk
- **Indicate substances flowing through a valve:** yellow = gas, green = water
- **Indicate different maintenance teams:** red = electricians, blue = mechanics



All Purpose Cable Lockout

- Can be used to lock out valves, disconnect switches, circuit breakers and more
- Locks out multiple control points with a single device = reduced equipment costs
- Interchangeable cables, select the best type suited for the job
- The **ergonomic**, hand-fitted body makes it easy to get the cable tight
- High portability, a built-in eyelet helps keep the cable neatly coiled, prevents loose ends from dangling and causing a hazard when in use
- Body made of rugged impact-resistant nylon, withstands chemicals and corrosion
- **4 padlock holes**
- **Max. shackle diameter: 7 mm**
- **Min. shackle clearance: 20 mm**
- **Packaging: 1 piece**



Order Ref.	Description
050941	APCLO with Non-Conductive Nylon Cable (2.44 m)
050943	APCLO with Vinyl Coated Metal Cable (2.44 m)



Non-Conductive Nylon Cables (without device)

Order Ref.	Description	Diameter
050945	Nylon Cable – 2.44 m	3.18 mm
050948	Nylon Cable – 3.65 m	3.18 mm

Sheathed Metal Cables (without device)

Order Ref.	Description	Diameter
050947	Vinyl Coated Metal Cable – 2.44 m	4.76 mm
050950	Vinyl Coated Metal Cable – 3.65 m	4.76 mm
813642	Vinyl Coated Metal Cable – 3.00 m	4.00 mm



Mini Cable Lockout

- Locks out valves as well as disconnected switches and circuit breakers
- 1 device for both electrical and mechanical lockout applications saves time and money
- Fits in the palm of your hand and is easily stowed away in your toolbox
- Cable stored internally: works just like a tape measure, prevents cable from getting tangled
- Push-button self-winding mechanism automatically holds cable tight
- The sheathed metal cable provides extra strength for getting a tight fit on valves and levers
- Superior chemical, corrosion and temperature resistance
- Comes with vinyl-coated steel cable or nonconductive nylon cable
- **6 padlocks can be applied**
- **Max. shackle diameter: 7 mm**
- **Min. shackle clearance: 20 mm**
- **Packaging: 1 piece**



Order Ref.	Description	Dimensions Body	Dimensions Cable
050940	Mini Cable Lockout with steel cable	Ø 10 cm x 4.5 cm D	Ø 1.6 mm x 2.44 m
051442	Mini Cable Lockout with nylon cable	Ø 10 cm x 4.5 cm D	Ø 1.6 mm x 2.44 m



Universal Valve Lockout

Lockout gate valves using the cable attachment with the Universal Valve Lockout. See page 90 for more information. For this lockout you would need to order:

Order Ref.	Description
050924	Small Universal Valve Lockout Base Clamping Unit
050899	Large Universal Valve Lockout Base Clamping Unit
051395	Cable attachment with 2.44 metre sheathed cable

Mechanical Risk – Gate Valves



Brady Cable Lockout Device

- Locks out gate valves, gas cylinders, electrical devices...
- Comes with 1.8 or 3 m steel cable and unique hasp lockout device
- Provide extra information by combining the device with a tag (page 115)
- **6 padlocks can be applied**
- **Max. shackle diameter:** 9 mm
- **Min. shackle clearance:** 15 mm
- **Packaging:** 1 piece



Order Ref.	Description
800112	Cable Lockout Device + 1.8 m cable
800113	Additional Cable 1.8 m
800114	Cable Lockout Device + 3 m cable
800115	Additional Cable 3 m



Scissor-Lok™ Lockout Device

- Locks out multiple gate valves simultaneously
- Secures power cords, freestanding equipment, tanks, cylinders or safety guards...
- Made of heavy-duty chemical resistant nylon
- The cable and device can be combined in several ways (see examples)
- Available with either a 0.91 m or 3.04 m vinyl coated cable. When using own cable, the outside diameter must be 4.76 mm or less
- **3 Padlocks can be applied**
- **Max. shackle diameter:** 7 mm
- **Min. shackle clearance:** 19.05 mm
- **Packaging:** 1 piece



Order Ref.	Description
236921	Scissor Lok - 0.91 m
236922	Scissor Lok - 3.04 m



PRO-LOCK II® Cable Lockout Device

- Can only be opened and locked by using special tool (not included) →
- Compact and lightweight
- Moulded from an impact polymer polypropylene with stainless steel internal parts.
- UV stabilised
- Temperature resistance range: -50°C to 55°C
- **Diameter PRO-LOCK:** 50 mm
- **Cable length:** 1.50 m
- **Max. shackle diameter:** 6.5 mm
- **Min. shackle clearance:** 20 mm
- **Packaging:** 1 piece



Order Ref.	Description	Material	Colour
225203	Pro-Lock + cable 1.5 m	Polypropylene moulding & stainless steel	Red
225204	Pro-Lock + cable 1.5 m	Polypropylene moulding & stainless steel	Green
225205	Pro-Lock + cable 1.5 m	Polypropylene moulding & stainless steel	Yellow
225206	Operating tool	Polypropylene	Red
225207	Operating tool	Polypropylene	Green
225208	Operating tool	Polypropylene	Yellow

 Other cable lengths are available upon request



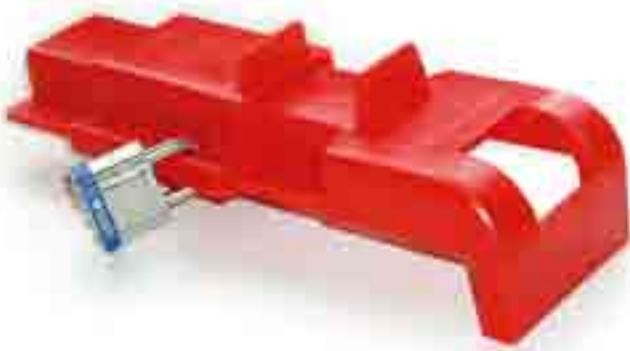

Butterfly Valve Lockout

Created to secure your butterfly valve efficiently!

- Made of strong polypropylene plastic
- Fully dielectric (non-conductive)
- Highly resistant to solvent and other chemical products
- Highly resistant to cracking and abrasion
- Resistant to extreme temperature changes from -46 to 183°C
- **2 Padlocks can be applied**
- **Max. shackle diameter: 8 mm**
- **Min. shackle clearance: 25 mm**
- **Packaging: 1 piece**



Order Ref.	Colour
256960	Red
256961	Yellow
256962	Green
256963	Blue



Available in 4 colours: Red, Yellow, Green & Blue

See page 92 for tips on how to use different colours

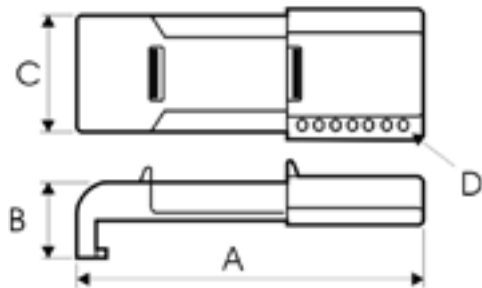
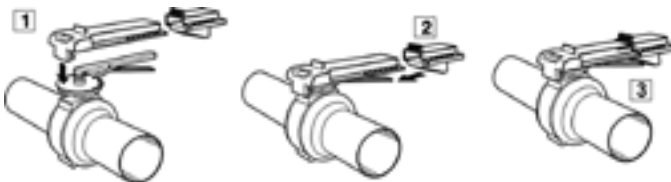

A	B	C	D
305 mm	70 mm	102 mm	9.5 mm



Universal Valve Lockout

Use the Universal Valve Lockout for locking out butterfly valves: the clamp attaches to the butterfly valve lever, preventing the trigger handle from being squeezed. The valve cannot be repositioned

See page 90 for more information. For this lockout format you would need to order:

Order Ref.	Description
050924	Small Universal Valve Lockout Base Clamping Unit
050899	Large Universal Valve Lockout Base Clamping Unit



Cylinder Tank Lockout

- Used to lockout cylinder tanks, including propane tanks on forklift trucks and stand alone propane tanks
- Valve stem hole is 31.5 mm in diameter
- Apply with ease to prevent access to the valve handle
- Designed to fit in tight spaces
- **2 padlocks can be applied**
- **Max. shackle diameter:** 6.5 mm
- **Min. shackle clearance:** 20 mm
- **Packaging:** 1 piece

Order Ref.	Description
046139	Cylinder Tank Lockout



Gas Cylinder Lockout

- Prevents access to the main cylinder valve
- No need to match your lockout device to varying diameters and threads of cylinder caps
- Accommodates neck rings up to 88 mm diameter
- Install in seconds to save time
- **1 padlock can be applied**
- **Max. shackle diameter:** 7 mm
- **Min. shackle clearance:** 20 mm
- **Packaging:** 1 piece

Order Ref.	Description
045629	Gas Cylinder Lockout



Pneumatic Quick-Disconnect Lockout

- Isolates pneumatic energy without the expense and inconvenience of installing in-line lockout valves
- Device is applied to the male fitting, isolating equipment from all compressed air sources
- Accommodates the majority of 6 mm, 9 mm and 12 mm male fittings
- Hole in centre of device allows for permanent storage on air hose and a loop on the side can be used to hang the hose and lockout device
- **Max. shackle diameter:** 6.5 mm
- **Min. shackle clearance:** 20 mm

Order Ref.	Description	Packaging
064221	Pneumatic Lockout	1 piece
065645	Pneumatic Lockout	6/pk



Combine Pneumatic Quick-Disconnect Lockouts with Brady Safety Padlocks (page 105)

Large Electrical/Pneumatic Lockout

- Accommodates a large variety of electrical plugs up to 89 mm diameter and 127 mm in length as well as male air hose connectors
- Works on 110V, 220V and 550V plugs
- Made of Polystyrene material
- **4 padlocks can be applied**
- **Max. shackle diameter:** 7 mm
- **Min. shackle clearance:** 20 mm
- **Packaging:** 1 piece.



Order Ref.	Description
800126	Large Electrical/Pneumatic Lockout



Lockout Devices for Plug Connections

- Especially developed to secure all types of plugs
- Highly effective against the unauthorised or incorrect use of electrical equipment
- Simple to use
- **Max. shackle diameter:** 7 mm
- **Min. shackle clearance:** 20 mm
- **Packaging:** 1 piece



Order Ref.	Type	Dimensions W x D x L (mm)	Lock holes
065674	Small	50 x 50 x 90	2
065675	Large	80 x 80 x 180	4

Large

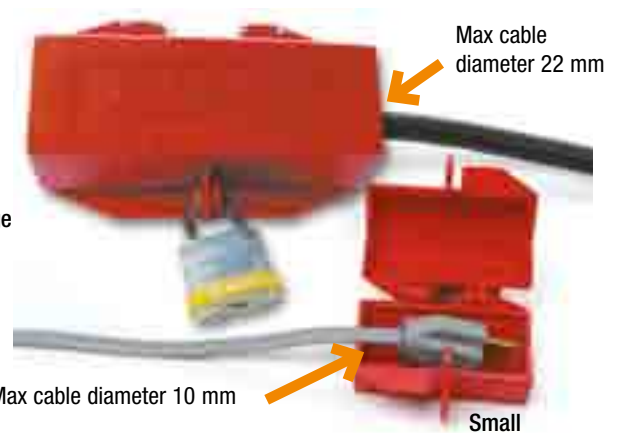

Small

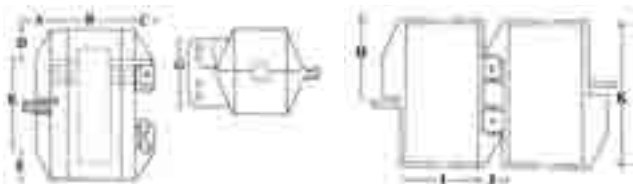

Order Ref.	Size in mm										
	A	B	C	D	E	F	G	H	I	J	K
065674	18	50	12	18	52	18	42	45	43	15	81
065675	25	90	16	40	97	40	70	85	76	25	167

Hubbell Plugout for Industrial Plug Connections

- Effectively secures all industrial plug connections
- Available in two sizes:
 - **Small:** connections with a max. diam. 7 cm / length of 12 cm / max. cable diam. 25 mm
 - **Large:** connections with a max. diam. 11.5 cm / length of 25 cm / max. cable diam. 35 mm
- **Max. shackle diameter:** 7 mm
- **Min. shackle clearance:** 20 mm
- **Packaging:** 1 piece



Order Ref.	Type	Plug diameter	Plug length	Cable diameter
065695	Small	7 cm	12 cm	25 mm
065968	Large	11 cm	25 cm	35 mm

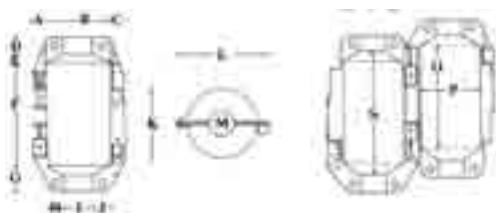
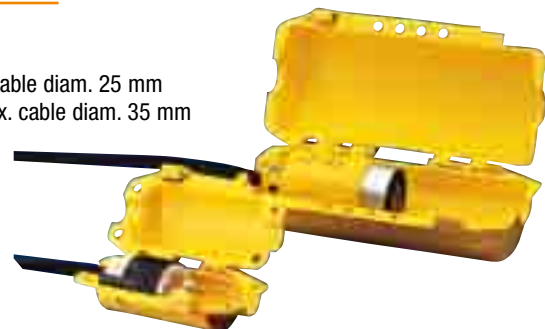

Order Ref.	Size in mm															
	A	B	C	D	E	F	G	H	I	J	K	L	M	N	O	P
065695	15	76	15	20	10	125	30	20	36	20	80	106	30	145	120	70
065968	-	-	-	15	-	285	15	18	125	18	120	120	-	286	290	120



Universal Multi-Pole lockout works with most two or three pole breakers utilising a tie-bar.

Universal Multi-Pole Breaker Lockout

- Made of durable impact-modified nylon
- Compatible with GE, ITE, Sylvania, Challenger, Bryan, Westinghouse, General Switch Co. ...
- Use thumbscrews to clamp lockout securely over tie bar, then insert lock to prevent clamp from being loosened
- **Max. shackle diameter:** 7 mm
- **Min. shackle clearance:** 20 mm



Order Ref.	Packaging
066321	1 piece
066320	6/pk



Combine Circuit Breaker Lockouts with Brady Safety Padlocks (page 105)



Economy Multi-Pole Breaker Lockout

- Economical solution!
- Designed to fit multi-pole breakers
- Quick and easy to apply
- **Max. shackle diameter:** 7 mm
- **Min. shackle clearance:** 20 mm



Order Ref.	Description
805814	Economy Multi-Pole Breaker Lockout



Single Pole Circuit Breaker Lockout

- Designed for breakers that have holes in the switch tongue
- Quick and easy – just snap in place and apply lock
- Dual cavities accommodate different size switch tongues
- **Dimensions (D x W x L):** 21 x 9 x 55 mm
- **Max. shackle diameter:** 7 mm
- **Min. shackle clearance:** 20 mm



Order Ref.	Packaging
065387	1 piece
065688	6/pk



How to apply:



Covering a breaker with a piece of duct tape to “lock it out” isn’t safe or effective and certainly doesn’t satisfy legislation. A Brady Lockout Device gives you a new level of safety and compliance.

“No Hole” Circuit Breaker Lockout

- Extremely versatile – works on wide range or single-pole and internal-trip multi-pole breakers
- 2 sizes: one for 120-277V breakers and one for 480-600V breakers
- Made of rugged polypropylene and glass filled impact modified nylon
- Use thumbscrews to clamp lockout securely onto switch tongue, then pull cover over thumbscrew and lock in place to prevent clamp from being loosened
- **Max. shackle diameter:** 7 mm
- **Min. shackle clearance:** 20 mm



Order Ref.	Description	Max. Switch width	Packaging
065396	277 Volt Device	16 mm	1 piece
065965	277 Volt Device	16 mm	6/pk
065397	480-600 Volts Device	38 mm	1 piece
065966	480-600 Volts Device	38 mm	6/pk



Oversized Breaker Lockout Device

- Oversized 480-600 Volt frame lockout, fits breakers up to 63.5 mm wide by 22.2 mm thick
- **Max. shackle diameter:** 7 mm
- **Min. shackle clearance:** 20 mm



Order Ref.	Packaging
065329	1 piece
065321	6/pk



480-600V Breaker Lockout

- Perfect for locking out oversized and irregularly shaped switches
- Self-adhesive backed rails are permanently installed onto an electrical panel – simply clean panel surface and adhere – no drilling required!
- Blocking bars (red and green) are 190 mm long
 - Red bar = indicates locked “off”
 - Green bar = indicates locked “on”



- **Max. shackle diameter:** 6.5 mm
- **Min. shackle clearance:** 20 mm



Breaker Blocker Kit

Order Ref.	Description
090891	Breaker Blocker Kit includes: 2 yellow mounting rails, 1 red blocking bar, 1 green blocking bar and 3 alcohol wipes.



Breaker Blocker Components

Order Ref.	Description	Packaging
090892	190 mm Red Blocking Bar	5/pk
090893	190 mm Green Blocking Bar	5/pk
051264	101 mm Yellow Mounting Rails	2/pk
051265	Blocking Bar Holder	5/pk



Blocking Bar Holder



Brady offers a variety of cable lockout devices that can be used for locking out electrical installations



Mini Cable Lockout

See page 93 for more information



All Purpose Cable Lockout



Tie-Bar (TBLO)



Pin-Out Standard (POS)



Pin-In Standard (PIS)



Pin-Out Wide (POW)

Miniature Circuit Breaker Lockouts

- A safe and effective method for locking out European Circuit Breakers.
- Will fit most existing types of European Circuit Breakers.
- Miniature Breaker Lockout unique in its kind = requires NO TOOLS to install! The Lockout easily installs with the aid of a Push Button. The Tie Bar Style Lockout has a convenient thumb wheel for quick application.
- Available for single and multi-pole breakers.
- Recommended to use in combination with a padlock for added safety. The lockouts can take padlocks with a shackle diameter up to 6 mm
- **Material:** glass-filled nylon

Each of these Breaker Lockouts are available in single pack or 6-pack

Order Ref.	Type	Packaging
090844	POS	1
090845	POS	6
090847	PIS	1
090848	PIS	6
090850	POW	1
090851	POW	6
090853	TBLO	1
090854	TBLO	6



Demo-kit

If you are uncertain about which pin you need, you can order our demo-kit which contains one example of each type of Miniature Breaker Lockout.

Order Ref.
805853

Breaker Compatibility Chart

Brand	Poles	Model No.	Order Ref.	Type
ABB	1	S222	090844	POS
ABB	1	F374	090844	POS
ABB	1	S251, S261, S263	090844	POS
ABB	1	S272, S253	090844	POS
ABB	3	S253	090844	POS
AEG	2	E82S	090847	PIS
Allen-Bradley	1,2,3	1492-CB1, 2, 3	090844	POS
Buschmat	1	S46	090844	POS
Clipsal	1	4CB116	090844	POS
Clipsal	3	4CB320	090844	POS
E-T-A	1	911225	090847	PIS
E-T-A	2	911220G	090844	POS
FAZ	4	C16	090844	POS
FAZ	1	C16	090844	POS
GE Vynckier	3	Series E	090847	PIS
GE Vynckier	3	Series G	090847	PIS
GE Vynckier	4	Series E	090847	PIS
GE Vynckier	1	Series G	090847	PIS
GE Vynckier 16A	2	Series E	090847	PIS
GE Vynckier C16, 16A	1	Series E	090847	PIS
Hager	3	453717	090844	POS
Hager	2	MW216A	090844	POS
Hager	4	MW620A	090844	POS
Kapp	1	LS68	090844	PIS
Legrand	2	01935	090844	TBLO
Legrand	3	01980	090844	TBLO

Brand	Poles	Model No.	Order Ref.	Type
Legrand	4	01980	090844	TBLO
Legrand	2	04302	090847	PIS
Legrand	3	06469	090847	PIS
Legrand	1	01908	090844	POS
Merlin Gerin	3	C80A	090850/090853	TBLO/POW
Merlin Gerin	2	B100A	090850/090853	TBLO/POW
Merlin Gerin	1	C60N	090844	POS
Merlin Gerin	1	C32N	090844	POS
Merlin Gerin	2	C60N	090844	POS
Merlin Gerin	4	C60N	090844	POS
Merlin Gerin	3	C32N	090844	POS
Merlin Gerin	3	C45AD	090844	POS
Proteus	1	C16	090844	POS
Proteus	1	C6	090844	POS
Proteus	3	C6	090844	POS
Siemens 17U	2	5SQ12	090853	TBLO
Siemens 17U	3	5SQ13	090853	TBLO
Siemens 17U	4	5SQ16	090853	TBLO
Siemens 17U	1	5SQ11	090850	POW
Siemens C10	1	5SX1	090850	POW
Siemens C32	2	5SX1-2	090853	TBLO
Siemens C70	3	5SX13	090853	TBLO
Siemens L20A	2	5SN2-2	090853	TBLO
Sursum	3	EA53	090847	PIS
Wylex	2	WRS40/2	090844	POS



Brady is pleased to introduce a new range of well-equipped Lockout Tagout kits. The kits are designed to help workers to establish an effective and safe lockout programme and to help them comply with company lockout procedures and health and safety regulations. The range consists of seven different Lockout Tagout kits. Each kit has been designed with a different need in mind. For example – isolating electrical energy.

Remember - an effective lockout procedure saves time, saves money, and saves lives!

Ultimate Lockout Kit

This is our most extensive Lockout Tagout kit and includes everything a larger company might need for their Lockout Tagout programme as well as training material.

Content:

- Large Universal Valve Lockout base clamping unit
- Large blocking arm
- Cable attachment
- Adjustable gate valve device
- APCL0 with sheathed metal cable
- Large plug lockout device
- Red butterfly valve lockout
- Cylinder tank lockout
- Gas cylinder lockout
- Mini cable lockout
- 227 V no hole circuit breaker
- 480-600V no hole circuit breaker
- 480-600V Breaker blocker kit
- Miniature circuit breaker demo kit (1 of each type)
- Economy multipole breaker
- Nylon lockout hasp
- 1 pack of red safety padlocks
- 25 mm red safety lockouts (1 pack)
- Duffel bag
- DVD - 9 basic steps
- DVD - Lockout for life
- "Do not operate" tag 75 x 160 mm
- Large lockout pouch
- Lockout belt pouch
- Pen

Order Ref.	Description
806178	Ultimate Lockout Kit



Lockout Kits

Valve and Electrical Lockout Kit

Content:

- Large Universal Valve Lockout base clamping unit
- Large blocking arm
- Cable attachment
- Adjustable gate valve device
- APCL0 with sheathed metal cable
- Large plug lockout device
- 227V no hole circuit breaker
- 480-600V no hole circuit breaker
- Economy multi-pole breaker lockout
- 480-600V breaker blocker kit
- Miniature circuit breaker demo kit (1 of each type)
- Nylon lockout hasp
- 1 pack of red safety padlocks
- 25 mm red safety lockouts (1 pack)
- Duffel bag
- "Do not operate" tag 75 x 160 mm
- Pen



Order Ref.	Description
806174	Valve and electrical lockout kit

Valve Lockout Kit

Content:

- Large Universal Valve Lockout base clamping unit
- Large blocking arm
- Cable attachment
- Adjustable gate valve device
- APCL0 with sheathed metal cable
- 1 pack of red safety padlocks
- 25 mm red safety lockouts (1 pack)
- "Do not operate" tag 75 x 160 mm
- Red lockout satchel



Order Ref.	Description
806175	Valve lockout kit

Electrical Lockout Kit

Content:

- Universal multipole breaker
- No hole circuit breaker
- No hole circuit breaker (480-600V)
- 277V Lockout cleat
- 480-600V lockout cleat
- Miniature circuit breaker kit
- 2 red Brady safety padlocks
- Nylon nonconductive hasp
- Red non conductive hasp
- Large red LOTO Pouch
- "Do not operate electrician at work" tag
- Pen



Order Ref.	Description
805909	Electrical lockout kit

Small adjustable Lockout Kit

Content:

- Large lockout pouch
- Adjustable gate valve device
- APCLO with sheathed metal cable
- 2 red Brady safety padlocks
- 2 red safety lockouts (25 mm)
- Small Universal Valve Lockout base clamping unit
- Small blocking arm
- Pen
- "Do not operate" tag 75 x 160 mm

Order Ref.	Description
806176	Small adjustable lockout kit



Lockout Intro Kit

Content:

- Small UVLO base unit
- Small blocking arm for use with UVLO
- Cable for use with UVLO
- APCLO with sheathed cable
- 2 red Brady safety padlocks
- Tag - blank
- Pen
- Large lockout pouch

Order Ref.	Description
805877	Lockout starter kit



Gate Valve Lockout Kit

Content:

- 25-64 mm red gate valve lockout
- 64-127 mm red gate valve lockout
- 127-165 mm red gate valve lockout
- 165-254 mm red gate valve lockout
- 254-320 mm red gate valve lockout
- Red lockout satchel
- 1 pack of red safety padlocks
- "Do not operate" tag 75 x 160 mm

Order Ref.	Description
806177	Gate valve lockout kit



Lockout Starter kit

- 2 x 25 mm Safety Lockouts (1 red + 1 yellow)
- 2 x 38 mm Safety Lockouts (1 red + 1 yellow)
- 6 x 38 mm Brady Safety Padlocks (one of each colour)
- 1 x nylon lockout hasp

Order Ref.	Description
805856	Mini lockout starter kit



Locks, Hasps & Accessories

5 Steps to help you choose the locks you need

1. Define which type suits best the application, use the below chart to help you out.
2. Define height and diameter of shackle (you will find this info with each LOTO device in this catalogue)
3. Choose a key system: Keyed Different, Keyed Alike, Master Keyed.
4. Choose the colour of the padlock.
5. Decide if the lock needs to be engraved or not

Choose the lock that's best suited for the job!

	Safety Padlock	Brass Padlock	Aluminium Padlock	Steel Padlock
Compact, lightweight	✓	✓	✓	
Nonconductive body & keyway	✓			
Most corrosion resistant	✓	✓		
Most spark resistant	✓	✓		
Most tamperproof	✓		✓	
Most rugged			✓	✓
Custom keying	✓		✓	✓
Engraving*		✓	✓	

*Only available as custom

Keying & Charting Options

Keyed Different

Brady padlocks are supplied “keyed differently” when purchased from stock. This means that the key for one lock should not open another. Brady padlocks use 5- or 6-pin cylinders to offer high levels of safety and security. Both cylinders and keys are precision-machined to exacting standards. This enables us to offer a greater number of unique keys than other locks with the same number of pins, making it highly unlikely that you will ever receive a duplicate lock. To guarantee that each lock is different, we can chart your locks, ensuring that each Brady padlock you receive is different from the others (contact your Brady distributor for more information).

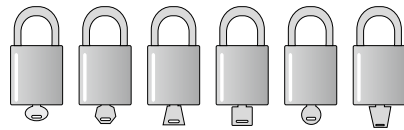

Keyed Alike

When keyed alike, all locks in a set can be opened with the same key. This option is beneficial when multiple locks are assigned to a single employee.

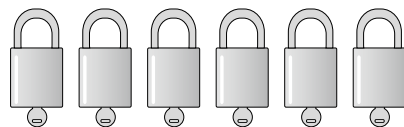

Master Keyed

A master key can be used to open multiple locks that are keyed differently. This allows supervisors to easily remove a lock in the event of an emergency. In order for employees to retain exclusive control, master keys should be kept in a secure location that is accessible only to management.

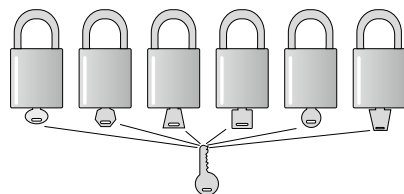

Grand Master Keyed

The master key system can be extended to several teams. This way each team has a master key and all the locks of all the teams can be opened by a ‘Grand’ Master Key if necessary.

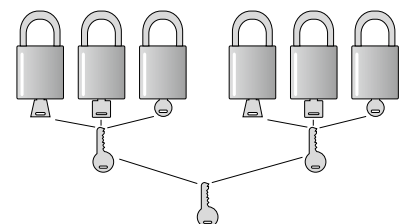

Brady Safety Padlocks:

The dedicated Lockout Padlock

- Compact and lightweight
- Enhanced impact resistance
- Nonconductive, nonsparking body
- Ideal for electrical applications
- Ribbed design for easy gripping and handling
- Made of rugged reinforced nylon with hardened steel shackle
- Superior temperature, chemical and corrosion resistance
- Locks come standard with English, French and Spanish language labels
- **Locks are supplied keyed differently**
- **Custom keying and charting also available**
- One key supplied with each padlock



Dimensions		
38 mm	87 mm	16 mm
18.5 mm	38 mm	6.5 mm

6 Padlocks/Package	
Order Ref.	Colour
051344	Blue
051339	Red
051353	Black
051346	Yellow
051345	Green
051347	Orange
813636	Brown
813637	Violet
813638	White

Unique Cylinder Enhances Safety & Security!

- Patented insulated key chamber protects workers from shocks when key is inserted
- 6-pin precision-machined cylinder offers more unique key cuts, better tamper resistance
- Reserved, paracentric keyway provides optimal security
- Key won't release until padlock shackle is closed

Brady Safety Padlocks with Plastic Shackle

Besides all the characteristics of the padlocks featured above, the safety padlock with plastic shackle has the added advantage of being fully electrical resistant. The plastic shackle cuts off the electrical current from the shackle to the key.

These locks standard come in "key different" (KD) version.

Keyed Alike, Master Key and Grand Master Key are available on request.



6 Padlocks/Packet	
Order Ref.	Colour
813593	Blue
813594	Red
813595	Black
813596	Yellow
813597	Green
813598	Orange
813639	Brown
813640	Violet
813641	White

Dimensions		
38 mm	87 mm	16 mm
18.5 mm	38 mm	6.5 mm

Brady Steel Padlocks with 20 mm shackle

6 Padlocks/Package	
Order Ref.	Colour
051280	Blue
051279	Red
051284	Black
051282	Yellow
051281	Green
051283	Orange

Dimensions		
40 mm	60 mm	26 mm
18.5 mm	20 mm	7 mm

Brady Steel Padlocks

- Reinforced laminated steel withstands severe physical abuse
- Hardened steel shackle difficult to cut
- Body plates individually coated for superior rust protection
- 5-pin cylinder offers more unique key cuts, better tamper resistance than conventional 4-pin locks
- Coloured bumpers supplied for identification and protection
- **Locks are supplied keyed differently**
- **Custom keying and charting also available**
- Two keys supplied with each padlock

Brady Steel Padlocks with 38 mm shackle

6 Padlocks/Package	
Order Ref.	Colour
805816	Blue
805815	Red
805819	Black
805817	Yellow
805818	Green
805820	Orange

Dimensions		
40 mm	72 mm	26 mm
18.5 mm	38 mm	7 mm



Brady Steel Padlocks with 50 mm shackle

6 Padlocks/Package	
Order Ref.	Colour
051291	Blue
051290	Red
051299	Black
051297	Yellow
051292	Green
051298	Orange

Dimensions		
40 mm	87 mm	26 mm
18.5 mm	50 mm	7 mm

Locks, Hasps & Accessories

Aluminium Padlocks

Solid aluminium body with hardened chrome-plated steel shackle

- Lightweight yet rugged
- Chemical and corrosion resistant
- 6-pin cylinder offers more unique key changes, better tamper resistance
- **Locks are supplied keyed differently**
- **Custom keying and charting also available**
- Two keys supplied with each lock
- Designed to withstand rugged work environments



Aluminium Padlocks with 25 mm shackle

6 Padlocks/Package		Dimensions		
Order Ref.	Colour			
051361	Blue	40 mm	73 mm	18 mm
051360	Red			
051369	Black	19 mm	25 mm	6.5 mm
051363	Yellow			
051362	Green			
051368	Orange			

Aluminium Padlocks with 38 mm shackle

6 Padlocks/Package		Dimensions		
Order Ref.	Colour			
051371	Blue	40 mm	83.35 mm	18 mm
051370	Red			
050274	Black	19 mm	38 mm	6.5 mm
051377	Yellow			
051376	Green			
051378	Orange			

Brass Padlocks: locks that will never rust!

Solid brass body and shackle

- Spark resistant ideal for use in flammable environments
- Corrosion resistant
- 6-pin cylinder offers more unique key cuts, better tamper resistance
- Locks protected by coloured vinyl sheaths
- **Locks are supplied keyed differently**
- Two keys supplied with each lock



12 Padlocks/Package		Dimensions		
Order Ref.	Colour			
051355	Blue	43 mm	59 mm	17 mm
051354	Red			
051359	Black	20.5 mm	21.5 mm	6.5 mm
051357	Yellow			
051356	Green			
051358	Grey			

Brass Padlocks with Stainless Steel Shackle

Solid brass body (chrome plated) with stainless steel shackle

- Corrosion resistant
- Precision pin tumbler cylinder
- **Locks are supplied keyed differently, keyed alike upon request**
- Two keys supplied with each lock



6 Padlocks/Package		Dimensions			Pins
Order Ref.					
805827	30 mm	47 mm	12 mm	4	
	14.5 mm	14.5 mm	6.5 mm		
805828	39 mm	66 mm	13 mm	5	
	19.5 mm	23.5 mm	6.5 mm		
805829	39 mm	83 mm	13 mm	5	
	19.5 mm	38 mm	6.5 mm		
805830	49 mm	73 mm	15 mm	5	
	28 mm	27 mm	7 mm		

Fully Insulated Lock

- Solid brass body
- Sealed lock body with cylinder cover to protect cylinder from dirt
- 5-pin cylinder
- Inner components made from non-corrosive materials
- Shock absorbing vinyl casing, protects painted surfaces
- Hardened or stainless steel shackle
- Body and shackle fully insulated against electric shock
- **Locks are supplied keyed differently, keyed alike upon request**



Order Ref.	Type	Dimensions			Padlocks/Package
805836	Stainless steel shackle (blue)				6
		53 mm	73 mm	28 mm	
		20,5 mm	24,5 mm	8 mm	
805835	Hardened steel shackle (grey)				6
		53 mm	73 mm	28 mm	
		20,5 mm	24,5 mm	8 mm	

Ultimate Security Padlock

- Shackle and body made of highest standard hardened alloy steel
- Abus-Plus 7 pin disk cylinder for ultimate protection against manipulation and key interchanges
- **Locks are supplied keyed differently, keyed alike upon request**



Order Ref.	Dimensions			Padlocks/Package
805837				3
	63 mm	85 mm	31 mm	
	27.5 mm	26 mm	11 mm	
805838				3
	63 mm	109 mm	31 mm	
	27.5 mm	50 mm	11 mm	
805839				1
	63 mm	134 mm	31 mm	
	27.5 mm	75 mm	11 mm	

Brass Padlock

- Brass body and hardened steel shackle
- All inner components non-corrosive
- Precision pin tumbler cylinder
- **Locks are supplied keyed differently, keyed alike upon request**



Order Ref.	Dimensions			Padlocks/Package	Pins
805831				6	4
	30 mm	47 mm	12 mm		
	14.5 mm	14.5 mm	5 mm		
805832				6	5
	39 mm	66 mm	13 mm		
	19.5 mm	23.5 mm	6.5 mm		
805833				6	5
	39 mm	83 mm	13 mm		
	19.5 mm	38 mm	6.5 mm		
805834				6	5
	49 mm	73 mm	15 mm		
	28 mm	27 mm	7 mm		

Brass I.D. Tags

- Instant identification of assigned padlock user
- Withstands rugged work environments
- Can be engraved by using engraver or stamp kits
- **Max. shackle diameter: 9.5 mm**



Order Ref.	Description	Packaging
265378	Brass tags & attachment rings	12
265379	Collars and rivets	12

"Cobra" Cable

Flexible steel wire with protective PVC coating for use with padlock



Order Ref.	Dimensions
805844	Ø 8 mm / 200 cm long

Maximum Chain Security

- Far more secure than steel cables
- Chain made from hardened special chain steel
- Fabric sleeve protects paint work and chrome from damage



Order Ref.	Dimensions
805845	Ø 8 mm / 110 cm long
805846	Ø 10 mm / 110 cm long

Non-Conductive Lockout Hasp

- Made of strong, rigid red plastic resin
- Offers high flexibility, resistance to cracking and most chemicals
- Has excellent electrical insulating characteristics
- Performs at low temperatures, excellent heat resistance
- Lockout Shackle fits in holes with a diameter of minimum 10 mm
- **Max. shackle diameter:** 9 mm
- **Min. shackle clearance:** 20 mm
- **Packaging:** 1 piece



Order Ref.	Description
045582	Nonconductive Lockout Hasp



Nylon Lockout Hasp

- Non-conductive nylon hasps accommodates up to 6 locks
- Withstands up to 450 kg, yet weighs only 30 g
- Locks out any piece of equipment safely and effectively
- Lockout Shackle fits in holes with a diameter of minimum 7 mm
- **Max. shackle diameter:** 9 mm
- **Min. shackle clearance:** 20 mm
- **Packaging:** 1 piece



Order Ref.	Description
236916	Nylon Lockout Hasp



Safety Lockout

- Allow six workers to lock out a single energy source
- Vinyl coated high tensile steel
- Available in red and yellow
- Available in 2 sizes
- **Max. shackle diameter:** 9.5 mm
- **Min. shackle clearance:** 20 mm
- **Packaging:** 12 pieces

Order Ref.	Shackle width	Colour
805840	25 mm	Red
805841	38 mm	Red
805842	25 mm	Yellow
805843	38 mm	Yellow



Economy Lockout

- Used on fuse or switch boxes
- Sturdy steel
- Hasp: 25.4 mm
- Accepts 6 padlocks
- **Max. shackle diameter:** 10 mm
- **Min shackle clearance:** 20 mm
- **Packaging:** 1 piece



Order Ref.
236920



Stubby Lockout

- To be used when lockout conditions vary in size
- Two hasp sizes: one is 31.75 x 44.45 mm the other has a 19 mm diameter
- Lockout small switch boxes to large control units and levers with one device
- No need for separate hasps of different sizes
- Accepts 6 padlocks
- **Max. shackle diameter:** 10 mm
- **Min shackle clearance:** 20 mm
- **Packaging:** 1 piece



Order Ref.
236919



Heavy Duty Steel Lockout

- Tamperproof design prevents vandalism
- Solid U-shape steel bolt cannot be pried apart once locks are in place
- Holds up to 3 locks
- Inside diameter of U-shape bolt 25.4 mm
- **Max. shackle diameter:** 9 mm
- **Min. shackle clearance:** 20 mm
- **Packaging:** 1 piece



Order Ref.	Description
236918	Lockout device
230000	Lockout device + chain (150 mm)

Labelled Safety Lockout Hasps

- Combination of lockout and tagout
- A single employee can lock out and service equipment
- Up to 5 additional employees can apply their locks and tags
- Tough 5052 anodised aluminium alloy
- Use pens, pencils and permanent markers
- Print from pens and pencils can be erased
- **Size:** 184.1 x 76.2 x 4.7 mm
- **Max. shackle diameter:** 8 mm
- **Min. shackle clearance:** 20 mm
- **Packaging:** 5 pieces



Order Ref.	Text
265390	Do not operate
265393	Ne pas faire fonctionner
265391	Nicht schalten
265392	Niet bedienen

 See page 115 for permanent markers

Blank Safety Lockout Hasps

- **Material:** aluminium
- **Size:** 184.1 x 76.2 x 4.7 mm
- **Max. shackle diameter:** 8 mm
- **Min. shackle clearance:** 20 mm
- **Packaging:** 5 pieces



Order Ref.	Colour
265399	Red
225199	Blue
225198	Green
225197	Gold
225196	Silver



BRADY Customize-it

Combine these blank hasps with customised labels. With or without a logo, with or without a bar code, your own specific text...

Contact your Brady Distributor for more information.

Lockout Stations & Lock Boxes

Lock Boards

Brady's high visibility lock boards make your locks, tags and lockouts easy to find and use. Built for the toughest conditions, these lock boards are made of durable plastic material.

The lock boards are available as boards only. No components are included.



5-Lock Board

- Dimensions: 29.2 x 39.3 cm

Order Ref.	Description
050989	5-Lock Board (board only)



10-Lock Board

- Dimensions: 34.2 x 34.2 cm

Order Ref.	Description
050990	10-Lock Board (board only)

See pages 114-116 for tags

See pages 104-107 for padlocks

See page 108 for hasps



20-Lock Board

- Dimensions: 59.7 x 29.2 cm

Order Ref.	Description
050991	20-Lock Board (board only)



36-Lock Board

- Dimensions: 54.6 x 59.7 cm

Order Ref.	Description
050992	36-Lock Board (board only)

Adjustable Lockout Stations

- Constructed of sturdy polystyrene with pre-drilled holes for easy wall mounting
- Pegboard-style holes for hooks drilled into back and sides
- Hooks can be arranged in a multitude of ways

The lockout stations are available as boards only. No components are included.



Extra-Large Lockout Station

Dimensions: 76.2 x 63.5 x 13.3 cm

Order Ref.	Description
050993	Extra-Large Lockout Station (station only)

Large Lockout Station

- Dimensions: 66 x 49.5 x 12.7 cm

Order Ref.	Description
050994	Large Lockout Station (station only)



Small Lockout Station

- Dimensions: 46 x 30.5 x 10 cm

Order Ref.	Description
050997	Small Lockout Station (station only)

Portable Lockout Station

- Dimensions: 43.2 x 43.2 x 17.1 cm

Réf.	Description
811217	Portable Lockout Station (station only)



Industrial Strength Lockout Station

- Lockable all metal, yellow powder coated cabinet
- One adjustable shelf (extra shelves available)
- Lockout Safety tips on inside of door
- Can hold a wide variety of lockout devices
- Can be wall mounted or easily transported
- Dimensions (H x W x D): 40.6 x 35.5 x 15.2 cm

Order Ref.	Description
800123	Industrial Strength Lockout Station
800129	Extra Shelf

Lock Boxes & Padlock Centres



Group Lock Box

- Simplifies lockout of large equipment
- After machine or process is locked out, the key or keys of the machine are placed in a lock box. Each authorised work team member places a personal lock or tagout device in the group lock box.
- Ensures that no single employee has access to the box unless ALL employees have removed their locks or tags
- **Packaging:** 1 piece

Order Ref.	Colour	Dimensions
065699	Red (with holes)	230 x 88 x 150 mm
045190	Blue (with holes)	230 x 88 x 150 mm
065672	Yellow (without holes)	230 x 88 x 150 mm



Group Lockout Centre

- 18 hooks for keys and 2 slots for locks (not included)
- Apply a padlock to the key box to lock out multiple sources of energy controlled by the padlock keys inside the box
- Made of acrylic
- Not designed to prevent forced entry.
- **Packaging:** 1 piece

Order Ref.	Description	Dimensions (H x W x D)
800127	Lockout Centre 18 hooks	19.5 x 40.6 x 6.4 cm
800116	Lockout Centre 8 hooks	19.5 x 30.5 x 6.4 cm
800117	Lockout Centre 3 hooks	15 x 15 x 8 cm



Padlock Control Centre

- Red powder coated steel
- Each nickel coated metal hook is large enough to hold two locks (not included)
- Two keys provided for cabinet lock.
- **Packaging:** 1 piece

Order Ref.	Description	Dimensions (H x W x D)
800118	Centre - 18 hooks	39.4 x 45.7 x 5 cm
800119	Centre - 8 hooks	25.4 x 30.5 x 5 cm



Portable Padlock Station

- Holds up to 10 padlocks, 6 lockout hasps and 10 tags
- Made from polypropylene: light and rustproof
- Predrilled holes: easy to mount on wall
- **Dimensions (W x H x D):** 17.8 x 33.7 x 6.4 cm
- Supplied without content
- **Packaging:** 1 Piece

Order Ref.	Description
811218	Portable Padlock Station (station only)



Padlock Station

- Steel padlock holder with red plastic coating
- Small holder allows up to 6 padlocks
- Large holder allows up to 36 padlocks
- Padlocks not included
- **Packaging:** 1 piece

Order Ref.	Description	Dimensions (W x H x D)
800120	Small Padlock Station	7.6 x 5.7 x 3.1 cm
800121	Large Padlock Station	40.6 x 7.6 x 3.1 cm



Large Lockout Pouch

- Made of nylon with attachment loop on back
- Create your own custom lockout kit and use the pouch to store it neatly
- **Dimensions (H x W x D):** 20.3 x 17.8 x 7.6 cm
- **Packaging:** 1 piece

Order Ref.	Description
050979	Large Lockout Pouch



Lockout Belt Pouch

- Made of heavy duty nylon with loops for hanging on a belt
- Simply fill the pouch with the lockout devices you need and have them handy when they are required
- **Dimensions (H x W x L):** 12 x 19 x 5 cm
- **Packaging:** 1 piece

Order Ref.	Description
051172	Lockout Belt Pouch



Lockout Satchel

- Made of 1000 denier red cordura nylon with a 95 cm shoulder strap.
- Includes latchable front pocket and two side mesh holders.
- **Dimensions (H x W x D):** 35.5 x 10 x 38 cm
- **Packaging:** 1 piece

Order Ref.	Description
806200	Lockout Satchel



Lockout Duffel Bag

- Made of 600 denier polyester with a 95 cm removable shoulder strap and 8 inside pockets
- **Dimensions (H x W x L):** 12.5 x 42 x 21.5 cm
- **Packaging:** 1 piece

Order Ref.	Description
099162	Lockout Duffel Bag

Tagout



Tagout is the placement of a tag, which indicates that the energy-isolating device and the equipment being controlled **MUST NOT** be operated until the tag has been removed.



Maintenance and Quality Tags

- Back: blank
- **Packaging:** 10 tags
- **Size:** 75 x 160 mm
- **Material:** semi rigid polyester

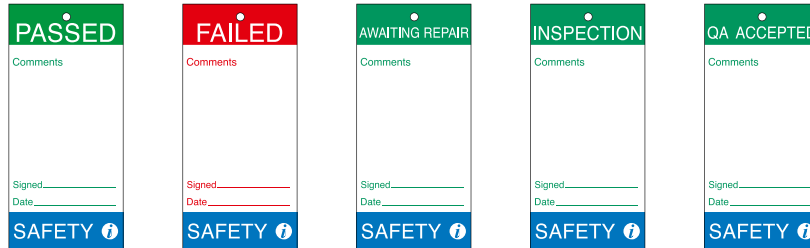

Order Ref. 230806 230807 230808 230809 230810

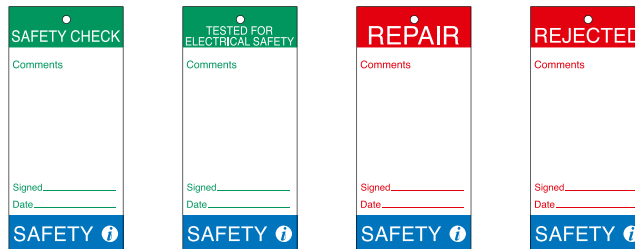

Order Ref. 230811 230812 230813 230814

Warning Tags: Machine Related Risks

- Back: blank
- **Packaging:** 10 tags
- **Size:** 75 x 160 mm
- **Material:** semi rigid polyester

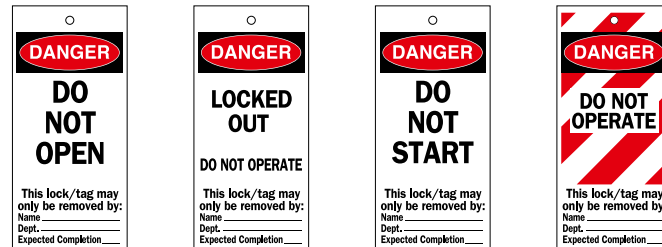

Order Ref. 230778 230779 230780 230781

Self-Adhesive Labels: Machine Safety

- **Packaging:** 1 label
- **Size:** 100 x 150 mm
- **Material:** laminated polyester



Order Ref. 230782 230783 230784 230785

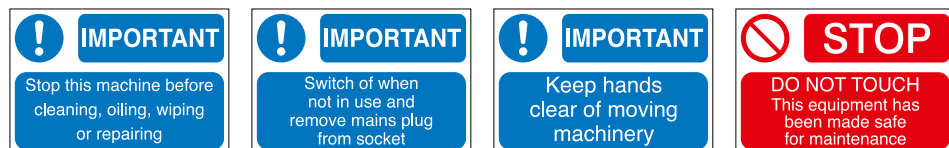

Order Ref. 230786 230787 230788 230789

Tagout: Warning Tags

Indicate who is responsible for placing a Lockout device and who is authorised to remove it or make changes to it. The tags are manufactured from a flexible polyester, resistant to water, oil and extreme temperatures. Their matt surface allows you to write on them easily with a ball point or felt-tip pen.

- **Packaging:** 10 tags with 10 cable-ties
- **Sizes:** A: 75 x 160 mm B: 50 x 110 mm

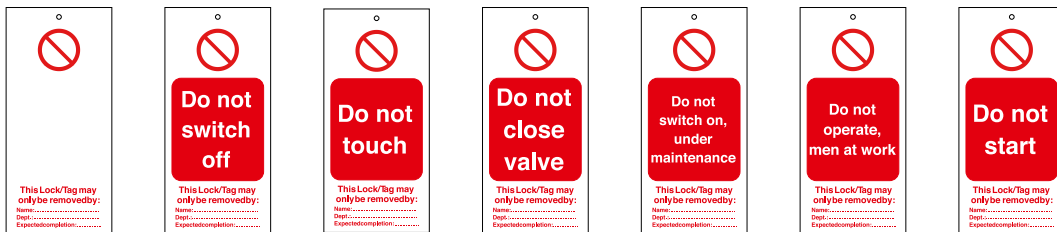

Order Ref. A	262950	262951	262952	262953	262954	262957	265549
Order Ref. B	225400	225401	225402	225403	225404	225405	225406

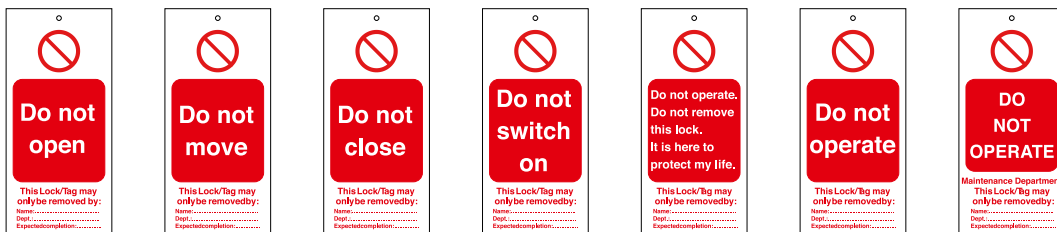

Order Ref. A	265550	262962	262964	262965	256564	265548	256565
Order Ref. B	225408	225409	225410	225411	225412	225407	225413

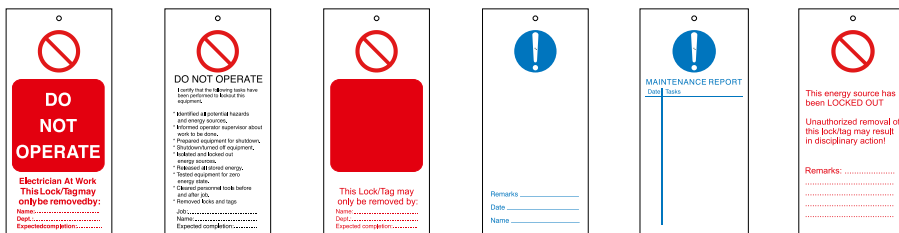

Order Ref. A	256566	256567	256571	225417	225419	Reverse
Order Ref. B	225414	225415	225416	225418	225420	



Order Ref. A	256572	256573	256575	256576	256577
Order Ref. B	225421	225422	225423	225424	225425



Order Ref. A	256578	256579	Reverse
Order Ref. B	225426	225427	



Order Ref.	Description
087052	Permanent marker



Tagout

Brady Safety Tags

- Brady Safety Tags provide on-the-spot identification of safety measures
- Very easy applications: can be attached in just seconds
- Tags have ties attached and can be applied to just about any part of any machine.
There is no need for extra ties!
- The tag is printed on both sides, making sure the vital information is always visible



Size:
Tag: 145 x 85 mm
Attachement tie: 15 x 140 mm

Packaging: 10 tags

Material: PVC 0.2 mm

Type	Order Ref.	Type	Order Ref.	Type	Order Ref.	Type	Order Ref.
Danger	241700	Caution, out of order	241701	Caution, men working on this equipment	241703	Danger, electric shock risk	241708
							
Danger, live wire	241710	Danger, contains asbestos	241712	Caution, biohazard	241713	Danger, radioactive material	241714
							
Do not use out of order	241716	Do not switch on	241717	Do not switch on under maintenance	241718	Do not touch	241719
							
Failed electrical safety test	241720	Tested for electrical safety	241721	Reverse			
							



Safety Tag Station

- Organises tags in a central location
- Accommodates 14.6 x 7.6 cm tags
- **Material:** Rugged Polycarbonate

Order Ref.
081773 (station only)



Tag Holder

- Compact
- Holds 50 tags, ties and marking pen (not included)
- Clear plastic
- Comes with adhesive strips and screws for mounting in a variety of ways

Order Ref.
800125 (station only)



Coloured Nylon Ties

- Allow colour coded application
- **Size:** 200 x 4 mm
- **Material:** nylon
- **Packaging:** 100 pieces

Order Ref.	Colour
229955	White
229956	Blue
229957	Red
229958	Orange
229959	Yellow
229960	Green
229961	Violet
229962	Black

Magnetic Signs

- Easy to apply and remove
- **Size:** 105 x 148 mm
- **Packaging:** 5 pieces



Order Ref. 256964



256965



256966



256967



Contact Brady Customer Service for information about custom magnetic signs



Order Ref.	Size h x w (mm)	Colour
224058	305 x 225	blue
224059	157 x 220	blue
224060	110 x 220	blue

Large Pouches with Magnetic Strips

Ideal for attaching lockout procedures to metal racks, cabinets and other metal surfaces.

Material: vinyl
Packaging: 10 pouches



Pouches with Magnetic Loops

These pouches have two magnetically closing loops at the top, making them ideal to attach to trolleys and pipes.

Packaging: 10 pouches

Order Ref.	Size h x w (mm)	Colour
224061	295 x 230	blue
224062	155 x 220	blue

Brady "Customize-it" order form



Please complete the following steps to order your custom label
(If more than one is required, please photocopy the original form and complete it)

- Step 1:** Choose the desired **Tag**: tick where applicable
- Step 2:** Choose a **Size**
- Step 3:** Write the required **Quantity**
- Step 4:** Write the required **Text** in box provided
- Step 5:** **Fax** this filled out order form to Brady Customer Service

Tag



LOCKOUT TAGOUT

Sizes

- 75 x 160 mm
- 50 x 110 mm

Quantity

Packaging:
10 tags with 10 cable ties

..... packs

Your Text



LOGISTICS LABELLING

Logistics labelling: why?
Bin location labels

Numbers & Letters

Numbers & letters: introduction
Numbers & letters: sizes
Numbers & letters B-500: indoor use
Numbers & letters B-946:
indoor & outdoor use
Numbers & letters A4 size

120
121

General Logistics Labelling Products

Aluminium utility panels
Numbered panels
Easy Number
Paper labels on a roll

122
123
124

Magnetic Labelling

Magnetic numbers & letters
Blank magnetic labels
Magnetic pouches

125
126

127
127
127
127

Inspection Date Labels

Inspection date labels B-500
Inspection date labels B-429
Hole punch

131
132
132

Write-on labels

Write-on labels
Pens
Write-on tags
Coloured nylon ties

133
133
136
136

Logistics Labelling: Why?



All those who are professionally involved know that a well identified warehouse improves the efficiency of a company

Clear, accurate and informative identification can be linked directly to improving general efficiency.

- Now, you too can benefit from our experience and improve your effectiveness!
- Are you forever trying to cope with unidentified racks?
- Do you need to combine bar codes, logos and text on one label?



BRADY will help you find the solution that works best for your environment!

BRADY Customize-it

Because of the variety of information that can be printed on these types of labels or panels, part numbers are not shown here.

Please contact your Brady Specialist who will pass the variable information onto us.

HOW TO ORDER: SEE NEXT PAGES



Numbered Panels: Loading Dock Panels, Gangway Panels, Bin Panels



Bin Location Labels



Numbers & Letters



Write-on Labels

Bin Location Labels

These labels are ideal for unique and specialised identification in industry and warehousing

Bin Location Labels can be used for numerous applications:

- Clean and clear warehouse identification
- Machine labelling: internal numbering
- Product codification
- Inventory serialisation
- Alpha numeric coding
- Valve identification

Using these type of labels saves you a lot of time because we print the variable information on the labels for you. On one label you can combine variable text, part numbers, bar codes and logos. BRADY labels are manufactured quickly, efficiently and carefully, to meet your demands for clearer and more accurate methods of identification.

Choose the size, the colour and the material you need.



How to order?

1. Select Material.

- Laminated Polyester Permanent Adhesive
- Laminated Polyester Removable Adhesive
- Magnetic

2. Determine the appropriate size for your application.

3. Choose the appropriate colours. You may choose up to 4 from the following:

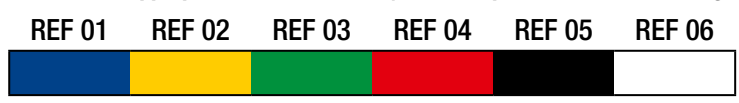

4. Determine the layout: please send us a sketch of how you would like the information to be positioned.

5. Determine the information you want to be printed:

- Serialised Number: starting point - end point - increment.
- Bar Codes
 - EAN 128
 - UPCA
 - 2/5 interleaved
 - Code 39
 - UPCE
- Text: number of characters and height, minimum character height = 2 mm.
- We can load digital information directly into our production machines (ASCII, Lotus, Excel or Dbase).

6. Determine total quantity per type of label.



Materials:

- **B-7541:** Self-adhesive polyester with permanent adhesive, suitable for indoor and outdoor use. Has a clear polyester overlaminate.
- **B-433:** Self-adhesive polyester with removable adhesive, label can be removed without leaving traces.
- **B-859:** Magnetic material, offers you complete flexibility when your warehouse changes its locations. Can be reused over and over again.

Options

Serialisation

8A-12 8A-13

8A-14

Multiple Print Directions

2078 A↑ B↓

Bar Codes

01-04-1

Logos

01235

Numbers & Letters: Introduction



The highly visible black and yellow markers from BRADY!
Durable • Waterproof • Non-fading • Scratch proof • Oil resistant



Brady's range of Numbers & Letters offer every company unlimited applications for labelling and marking. The highly visible characters improve safety by adding clarity, thus reducing any dangers caused by confusing or inadequate signage. Brady self-adhesive Numbers & Letters are made from either hard-wearing cloth coated with PVC (B-499 for the 3400 series) or from vinyl (B-946 for the 1500 series)

They can be used for marking just about anything in the work place: boxes, signs, doors, windows, shelves, equipment, machines and spare parts.

Brady Numbers & Letters for indoor applications (3400 series) are permanent, scratch proof and oil resistant.

Brady Numbers & Letters for outdoor use (1500 series) are especially weatherproof and UV light resistant.



FOR MARKING:

WAREHOUSES • OFFICES • TOOLS • MACHINES • RACKS • CUPBOARDS
SHELVES • BOXES • OFFICE EQUIPMENT

Character height (mm)	Readability Distance (m)
25	1.20 m
38	1.80 m
50	2.30 m
75	3.20 m
100	4.50 m
150	9 m

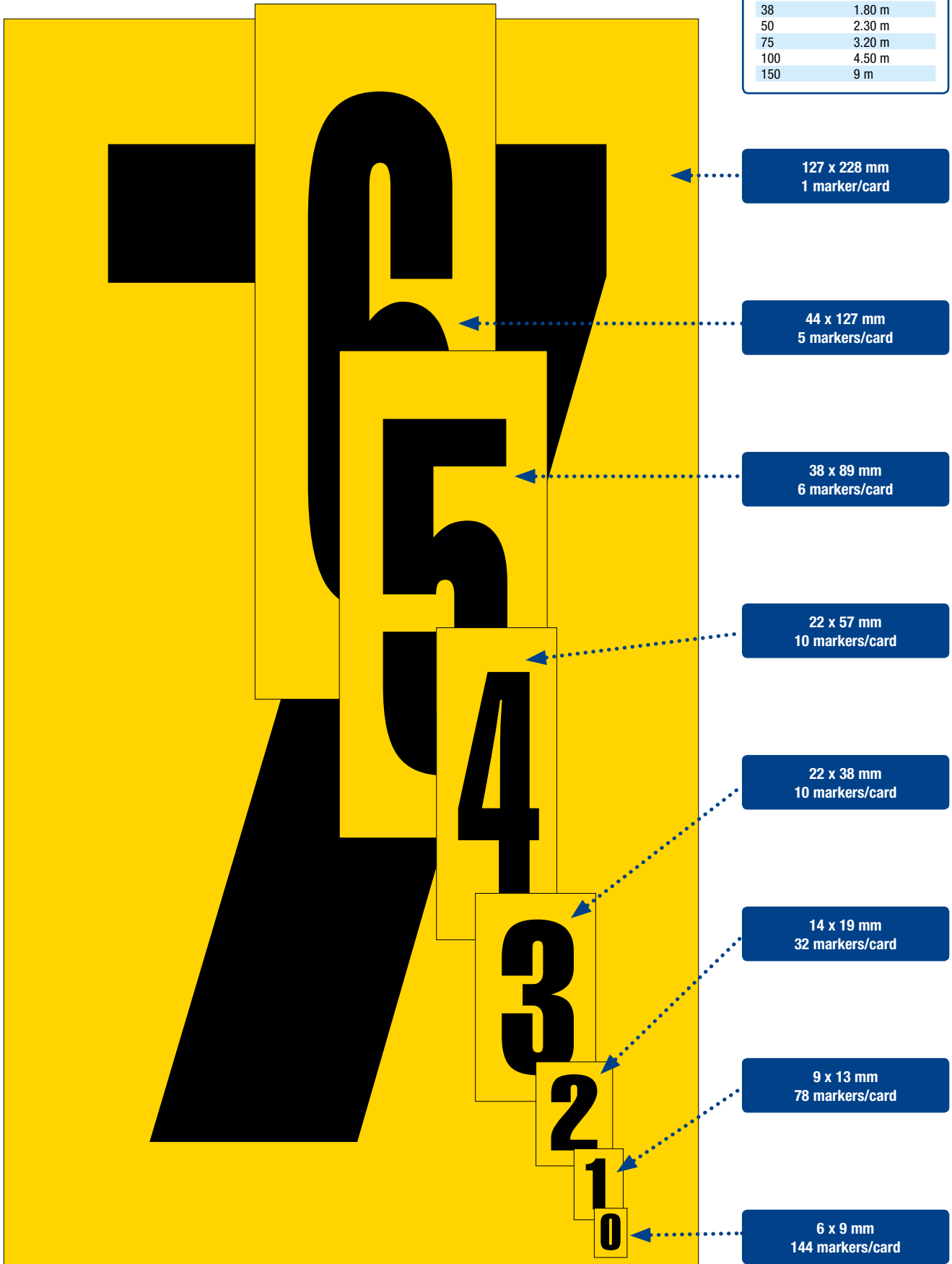

Numbers & Letters B-499: Indoor Use

Identical numbers or letters on one card

Ordering: In place of the asterisk, simply add the suffix for desired letters (A-Z), numbers (0-9), hyphens (DSH) or arrows (ARO) to the order reference shown in the table on the right.

Packaging: 25 identical cards per pack

Material: Vinyl cloth (B-499)



Order Ref.	Colour	Approximate label size w x h (mm)	Approximate character height (mm)	Labels per card
3400-*	Black on yellow	6 x 9	6.3	144
3410-*	Black on yellow	9 x 13	8	78
NL-W05-*	Black on white	9 x 13	8	78
3420-*	Black on yellow	14 x 19	16	32
NL-W75-*	Black on white	14 x 19	16	32
3430-*	Black on yellow	22 x 38	25	10
NL-W15-*	Black on white	22 x 38	25	10
CNL 1B-*	White on blue	22 x 38	25	10
CNL 1G-*	White on green	22 x 38	25	10
CNL 1R-*	White on red	22 x 38	25	10
CNL 1OR-*	White on orange	22 x 38	25	10
CNL 1GR-*	White on grey	22 x 38	25	10
3440-*	Black on yellow	22 x 57	49	10
NL-W225-*	Black on white	22 x 57	49	10
CNL 2B-*	White on blue	22 x 57	49	10
CNL 2G-*	White on green	22 x 57	49	10
CNL 2R-*	White on red	22 x 57	49	10
CNL 2OR-*	White on orange	22 x 57	49	10
CNL 2GR-*	White on grey	22 x 57	49	10
3450-*	Black on yellow	38 x 89	75	6
3460-*	Black on yellow	44 x 127	98	5
3470-*	Black on yellow	127 x 228	152	1



Series 3420, 3430, 3440 and 3450 + NL + CNL: hyphens (DSH) and arrows (ARO) are available
Series 3400, 3410, 3460, 3470: hyphens (DSH) are available, but no arrows.

Combination packs: Assorted Markers on a Dispenser Card

Ordering: By part numbers and type

Packaging: 25 cards per pack (26 cards per pack for order reference 034751 and 034752)

Material: Vinyl cloth (B-499)



See page 152 for a complete overview of the exact quantities of numbers or letters contained in each pack.

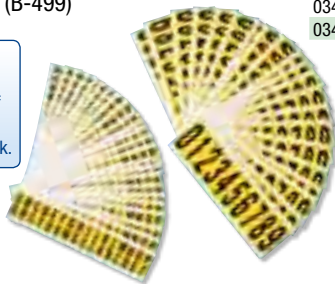

Order Ref. Numbers	Order Ref. Letters	Colour	Approximate label size w x h (mm)	Approximate character height (mm)	Labels per card
034052	034051	Black on yellow	6 x 9	6.3	144
034152	034151	Black on yellow	9 x 13	8	78
034252	034251	Black on yellow	14 x 19	16	32
034352	034351	Black on yellow	22 x 38	25	10
034452	034451	Black on yellow	22 x 57	49	10
034552	034551	Black on yellow	38 x 89	75	6
034652	034651	Black on yellow	44 x 127	98	5
034752	034751	Black on yellow	127 x 228	152	1

Consecutive Markers

Ordering: By part numbers

Packaging: 1 series per pack (25 identical cards per pack)
Consecutive B-500 markers contain numerical or alphabetical sequences on the same card. Small marker sizes contain complete numerical or alphabetical sequences. Larger sized cards break the alphabet into three parts: A-J, K-T and U-Z.

Material: Vinyl cloth (B-499)



See page 152 for a complete overview of the exact quantities of numbers or letters contained in each pack.

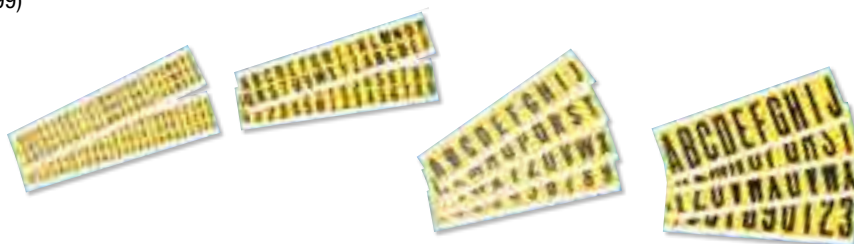

Order Ref.	Character	Colour	Approximate label size w x h (mm)	Approximate character height (mm)	Labels per card
034010	0 - 9	Black on yellow	6 x 9	6.3	144
034138	A - Z	Black on yellow	9 x 13	10	78
034110	0 - 9	Black on yellow	9 x 13	10	78
034238	A - Z	Black on yellow	14 x 19	16	32
034210	0 - 9	Black on yellow	14 x 19	16	32
034340	A - J	Black on yellow	22 x 38	26	10
034341	K - T	Black on yellow	22 x 38	26	10
034342	U - Z	Black on yellow	22 x 38	26	10
034310	0 - 9	Black on yellow	22 x 38	26	10
034440	A - J	Black on yellow	22 x 57	50	10
034441	K - T	Black on yellow	22 x 57	50	10
034442	U - Z	Black on yellow	22 x 57	50	10
034410	0 - 9	Black on yellow	22 x 57	50	10



B-946 vinyl: ideal for all applications, indoors or out

- Special resistant vinyl film
- Strong adhesive - even sticks to rough surfaces
- Print is resistant to abrasion
- Weatherproof and resistant to UV light
- Suitable for use in temperatures between -40°C and 82°C
- Waterproof, resistant to oils, alkalis, acids etc.

Identical numbers or letters on one card

Ordering: By part number with suffix for desired letters (A–Z), numbers (0–9), hyphens (DSH) or arrows (ARO)

Packaging: 25 cards per pack

Material: Vinyl (B-946)



 See page 152 for a complete overview of the exact quantities of numbers or letters contained in each pack.

Order Ref.	Colour	Approximate Label size w x h (mm)	Approximate Character height (mm)	Labels per card
1520-	Black on yellow	14 x 19	15	32
1530-	Black on yellow	22 x 38	25	10
1534-	Black on yellow	22 x 57	50	10
1550-	Black on yellow	38 x 89	75	6
1560-	Black on yellow	44 x 127	98	5
1570-	Black on yellow	127 x 228	152	1
9712-	Black on white	14 x 19	16	32
9713-	Black on white	22 x 38	25	10
9714-	Black on white	46 x 57	49	5

 Series 1560, 1570, 9712, 9713 and 9714: no arrows are available.

Numbers or Letters in Combination Packs

Ordering: By part number and type

Packaging: 25 card per pack: (except 097598: 26 cards per pack)

Material: Vinyl (B-946)

 See page 152 for a complete overview of the exact quantities of numbers or letters contained in each pack.



Order Ref. Numbers	Order Ref. Letters	Colour	Approximate Label size w x h (mm)	Approximate Character height (mm)	Labels per card
097601	097600	Black on yellow	14 x 19	15	32
097603	097602	Black on yellow	22 x 38	25	10
097605	097604	Black on yellow	22 x 57	50	10
097607	097606	Black on yellow	38 x 89	75	6
097129	097128	Black on yellow	44 x 127	98	5
097599	097598	Black on yellow	127 x 228	152	1
806201	806203	Black on white	14 x 19	15	32
806202	806204	Black on white	22 x 38	25	10
097711	097712	Black on white	46 x 57	49	5

Numbers & Letters A4 Size

Numbers & Letters DIN A4 Size for a Permanent or Temporary Identification

These numbers and letters are a unique tool to identify racks and gangways in your warehouse. Different colours enable you to identify in a very specific way: e.g. each range of products has a specific colour, or each floor or rack has a specific colour, etc.

Available Numbers & Letters:

LETTERS: A – Z

NUMBERS: 0 – 9

SYMBOLS: arrow, dot and hyphen

Available in the following materials:

- Self-adhesive overlaminated polyester (B-7541) – quick and easy to apply
- Rigid polypropylene (B-7527) – use in combination with Bradyfoam™ mounting tape
- Magnetic material (B-859)- ideal for temporary identification

Packaging: 1 piece



Available Colours

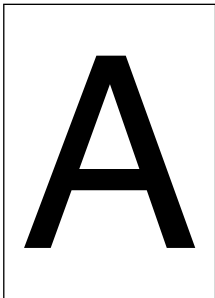

Black on white



White on red



White on blue



White on green

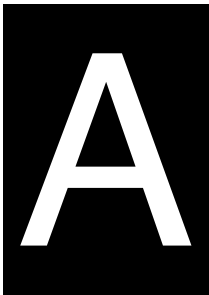

White on black

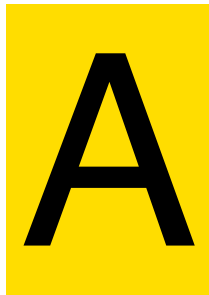

Black on yellow

How to order?

Example of order reference:

NL859A4YL-A: Letter A black on yellow, magnetic material

NL: the product (Numbers & Letters)

859: the material (B-859)

A4: the size (DIN A4 – 210 mm x 297 mm)

YL: the colour (YL: yellow)

-A: the number, letter or symbol



Use in combination with Bradyfoam™ Mounting Tape

- White polypropylene tape, is coated on both sides with high-tack, high-shear synthetic rubber adhesive for indoor and outdoor use
- Minimum application temperature: 10°C

Order Ref.	Packaging	Size
078273	1 Roll	19 mm x 33 m
019811	1 Roll	25 mm x 33 m
097200	Card of 4	19 mm x 11.4 cm



See page 62 for more mounting systems



Make your own projecting or corridor warehouse signs.

By using blank signs together with one of our standard Numbers & Letters you can add improved visibility to the warehouse sign of your choice.

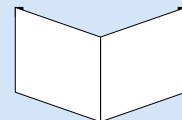
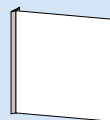

Corridor Sign Order Ref.	Projecting Sign Order Ref.	Size H x W (mm)
287134	253544	151 x 151
287119	253545	203 x 203
287128	253546	253 x 253
222582	222583	318 x 318
287126	222586	151 x 300
225184	225185	300 x 213
287133	222587	300 x 151
222584	222585	603 x 203
223990	223993	203 x 403
223991	223992	403 x 203



For easy application of Numbers & Letters on rough surfaces, use these aluminium utility panels.

The panels are slightly pliable and can be applied to hollow and rounded surfaces. Make your choice from the large range of Brady Numbers & Letters to combine with these panels:

- B-499:** Numbers & Letters in vinyl cloth (indoor use)
- B-946:** Numbers & Letters in vinyl (indoor and outdoor use)
- B-997:** Numbers & Letters in reflective material (indoor and outdoor use)

Thickness: 0.5 mm – **Packaging:** 25 panels
Delivered as blanks with 2 holes.

Order Ref.	Plate size (cm)	Marking area size (cm)	Recommended Numbers & Letters	Max. number of markers/panel
097198	4.5 x 18.4	4.5 x 16.5	B-499 / B-946 / B-997	8
097199	4.5 x 30.5	4.5 x 28.6	B-499 / B-946 B-997	12 11
097201	6.3 x 29	6.3 x 27	B-997	7
097202	8 x 34	8 x 32.3	B-997	7



Numbered Panels

Apply them on shelves, bins, loading docks, etc. These panels are available in different rigid or magnetic materials. The information printed on them, is specified by you! Make your choice as shown below and send the information you want on the panels to your Brady Specialist. For more information, please contact your Brady Specialist.

How to order?

1. **Select material:**
 - PVC (1.5 mm)
 - PVC (3 mm)
 - Magnetic Foil (0.6 mm)
2. Determine size
3. Determine layout and character height
4. Determine number and character range you want on the panels
5. Determine quantity of each panel type



The PVC panels can be attached using foamtape, screws, chains, etc.



Easy Number

The easy and fast way to label everything by using just one handy tool!

Order Ref.	Character height (mm)	Characters per card	Cards per pack
588042	30	10	25
588040	15	32	25



Dont forget to order a pen!

Order Ref.	Description	Colour	Packaging
335091	Fine	Black	1
335092	Ultra Fine	Black	1
055508	Fine (solvent based)	Black	1
055500	Ultra Fine (solvent based)	Black	1



Paper Labels On A Roll

Available in RED, YELLOW, GREEN and BLUE.
Comes in 2 sizes.

Packaging: 1 roll of 500 labels.

Blue Order Ref.	Red Order Ref.	Green Order Ref.	Yellow Order Ref.	Size	Labels/roll
030661	030662	030663	030667	38 mm	500
030665	030666	030667	030668	75 mm	500

Magnetic Numbers & Letters



Magnetic die-cut numbers and letters are designed for easy application to metal warehouse racks. They are extremely user friendly, can be applied to any metal cabinet or surface and can be reused many times. For added convenience, the die-cut labels peel back easily from their sheet. For the quantity of numbers or letters per sheet : see the tables below.

Thickness: 1mm

Colours: white or yellow background with black print

Packaging: 1 set

Magnetic Numbers on a sheet

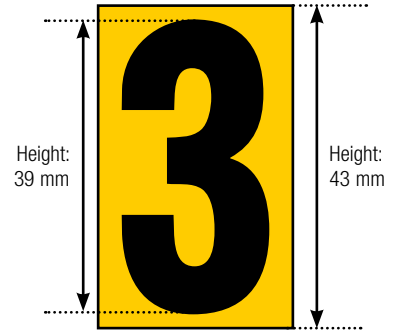
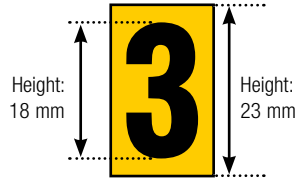
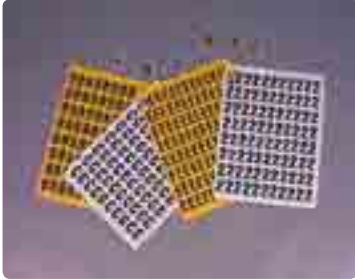

Order Ref.	Colour	Character Height (mm)
224063	Black on yellow	18
224064	Black on yellow	39
224065	Black on white	18
224066	Black on white	39

Number of characters per set			Number of characters per set		
Height: 18/23 mm			Height: 39/43 mm		
1	31 pcs	6	17 pcs	%	2 pcs
2	17 pcs	7	17 pcs	0	39 pcs
3	17 pcs	8	17 pcs	J	8 pcs
4	17 pcs	9	9 pcs	■	8 pcs
5	17 pcs	0	39 pcs	°	2 pcs
1	9 pcs	6	5 pcs	%	1 pc
2	5 pcs	7	5 pcs	0	10 pcs
3	5 pcs	8	5 pcs	J	2 pcs
4	5 pcs	9	5 pcs	■	4 pcs
5	5 pcs	0	10 pcs	°	3 pcs

Magnetic Letters on a sheet

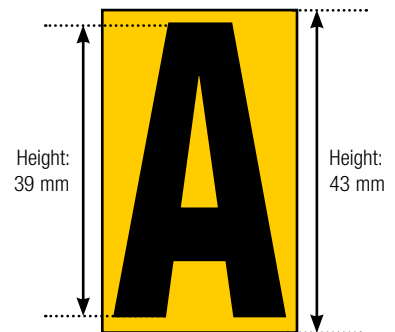
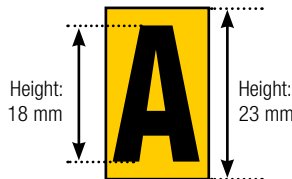

Order Ref.	Colour	Character Height (mm)
224067	Black on yellow	18
224068	Black on yellow	39
224069	Black on white	18
224070	Black on white	39

Number of characters per set			Number of characters per set		
Height: 18/23 mm			Height: 39/43 mm		
A	12 pcs	K	5 pcs	U	7 pcs
B	6 pcs	L	7 pcs	V	6 pcs
C	8 pcs	M	8 pcs	W	3 pcs
D	7 pcs	N	11 pcs	X	2 pcs
E	21 pcs	O	12 pcs	Y	2 pcs
F	7 pcs	P	5 pcs	Z	4 pcs
G	7 pcs	Q	3 pcs	J	6 pcs
H	6 pcs	R	9 pcs	■	6 pcs
I	14 pcs	S	8 pcs		
J	4 pcs	T	8 pcs		
A	3 pcs	K	1 pcs	U	3 pcs
B	2 pcs	L	2 pcs	V	2 pcs
C	2 pcs	M	2 pcs	W	1 pc
D	2 pcs	N	3 pcs	X	1 pc
E	4 pcs	O	2 pcs	Y	1 pc
F	2 pcs	P	2 pcs	Z	2 pcs
G	2 pcs	Q	1 pc	■	6 pcs
H	2 pcs	R	3 pcs	J	2 pcs
I	3 pcs	S	3 pcs	■	2 pcs
J	1 pcs	T	3 pcs	=	1 pc





Blank Magnetic Strips

These strips come in yellow or white and make it easy to identify metal racks, cabinets and products in no time at all. The magnetic material can be applied to any metallic surface and just as easily be removed and placed on another rack, cabinet, ...

Yellow and white are the standard colours but on request other colours can be supplied as well (black, green, blue, red, orange, brown, beige, grey and pink).

Sizes: 25 mm, 50 mm or 80 mm.

Thickness: 0.8 mm

Packaging: 1 roll (10 m)

Order Ref.	Size	Colour	Description
225171	25 mm	Yellow	Magnetic strips-YL-25mm x 10m-B-859
225172	25 mm	White	Magnetic strips-WH-25mm x 10m-B-859
225173	50 mm	Yellow	Magnetic strips-YL-50mm x 10m-B-859
225174	50 mm	White	Magnetic strips-WH-50mm x 10m-B-859
225175	80 mm	Yellow	Magnetic strips-YL-80mm x 10m-B-859
225176	80 mm	White	Magnetic strips-WH-80mm x 10m-B-859



Magnetic strips: Write-on / Wipe-off

Mark and identify racking and shelving quickly and easily with this flexible magnetic strip, enabling easy updates and relocation of the marker as and when required, whilst keeping the face of the racks clean in appearance. Use the wipe-off pen for writing on these strips.

Standard colours: yellow and white

Thickness: 0.6 mm

Packaging: 1 sheet (A4) or 1 roll (10 m)

Roll

Order Ref.	Size	Colour	Description
225178	25 mm	Yellow	Magnetic strips write-on/wipe-off-YL-25mm x 10m-B-859
225179	25 mm	White	Magnetic strips write-on/wipe-off-WH-25mm x 10m-B-859
225180	50 mm	Yellow	Magnetic strips write-on/wipe-off-YL-50mm x 10m-B-859
225181	50 mm	White	Magnetic strips write-on/wipe-off-WH-50mm x 10m-B-859

A4 Sheets

Order Ref.	Colour	Description
225182	White	Magnetic write-on/wipe-off A4 sheet-WH-B-0859
225183	Yellow	Magnetic write-on/wipe-off A4 sheet-YL-B-0859



Order these wipe-off pens to use on any of our write-on magnetic labels

Order Ref.	Colour	Description
225177	Black	Wipe-off marker black



Blank Write-on Magnetic Labels

Ideal for the identification of warehouses with a constantly changing layout. These type of labels offer complete flexibility. They can be applied and removed from metal surfaces as many times as necessary. When the locations change, these labels can move along with the products!

- Available in white (other colours available upon request).
- Available in different sizes (see table below – other sizes available upon request).
- Can be identified by writing on it or applying a self-adhesive label onto the magnetic material.

Packaging: 25 labels

Length						Width
45 mm	77 mm	108 mm	159 mm	216 mm	312 mm	
Order Ref.	Order Ref.	Order Ref.	Order Ref.	Order Ref.	Order Ref.	
234962	234963	234965	234966	234967	–	26 mm
234968	234969	234970	234971	234972	–	38.5 mm
–	–	234973	234974	–	234975	51 mm
–	–	234978	234979	–	234980	77 mm

Magnetic Pouches



Small Pouches with Magnetic Strips

- Ideal for marking stock on metal racks in warehouses.
- Magnetic strip on back of pouch for easy application.
- Very suitable for goods that have no permanent bin location.

Packaging: 20

Cardboard cards are not included, order separately!

Order Ref.	Size h x w (mm)	Description	Colour
224050	30 x 100	Pouches with magnetic strip	Yellow
224051	40 x 120	Pouches with magnetic strip	Yellow
224052	58 x 100	Pouches with magnetic strip	Yellow
224053	58 x 137	Pouches with magnetic strip	Yellow
224054	23 x 90	Cardboard cards	Yellow
224055	33 x 110	Cardboard cards	Yellow
224056	48 x 88	Cardboard cards	Yellow
224057	50 x 128	Cardboard cards	Yellow



Large Pouches with Magnetic Strips

Ideal for attaching forms (transport, stock, etc.) to metal racks, cabinets and other metal surfaces.

Material: vinyl

Packaging: 10 pouches (empty)

Order Ref.	Size h x w (mm)	Colour
224058	305 x 225	Blue
224059	157 x 220	Blue
224060	110 x 220	Blue



Pouches with Magnetic Loops

These pouches have two magnetically closing loops at the top, making them ideal to attach to trolleys and pipes.

Packaging: 10 pouches (empty)

Order Ref.	Size h x w (mm)	Colour
224061	295 x 230	Blue
224062	155 x 220	Blue

Inspection Date Labels B-500

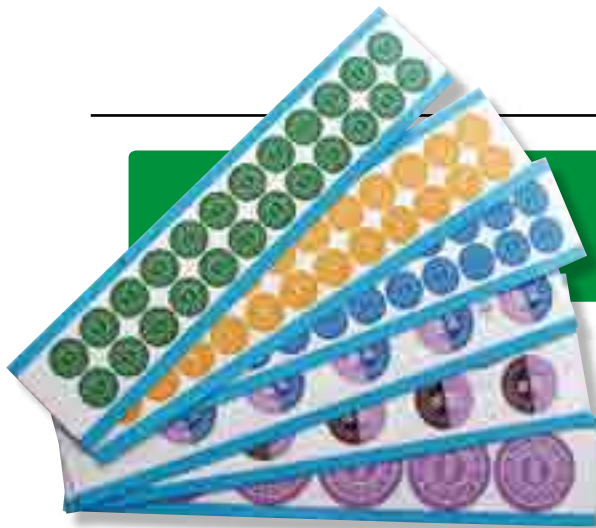

Inspection date labels can be used wherever a frequent and regular inspection of machinery and equipment is required. One example is the indication of the inspection date of the fire extinguishers. Simply mark the label with a hole punch (available from next page) and apply wherever you need it!

Material: (B-500) Vinyl cloth
Packaging: 1 pack of 25 cards

Size	Labels per card
Ø 15	24 Labels per card
Ø 25	10 Labels per card
Ø 35	5 Labels per card



Hole punch: see next page for more information



Vinyl Cloth



	10	11	12	13	14
Ø 15 mm	225186	806205	806206	806207	806208
Ø 25 mm	225187	806210	806211	806212	806213
Ø 35 mm	225188	806215	805216	804217	803218

	15	16	17	18
Ø 15 mm	806209	806295	813089	813091
Ø 25 mm	806214	806296	813120	813092
Ø 35 mm	802219	806297	813090	813093

	2010	2011	2012	2013	2014
Ø 15 mm	225189	806276	806277	806278	806279
Ø 25 mm	225190	806281	806282	806283	806284
Ø 35 mm	225191	806286	806287	806288	806289

	2015	2016	2017	2018
Ø 15 mm	806280	806298	813094	813097
Ø 25 mm	806285	806299	813095	813098
Ø 35 mm	806290	806300	813096	813099



Ø 25 mm	806291	806220	806221	806222
Ø 35 mm	806292	806224	806225	806226

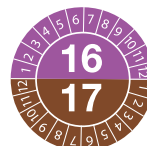

Ø 25 mm	806223	806307	813100
Ø 35 mm	806227	806308	813101

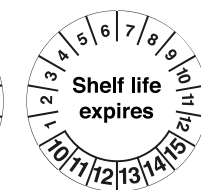
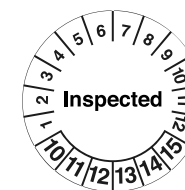
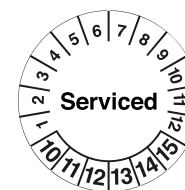
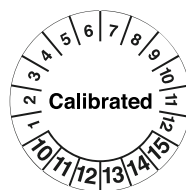
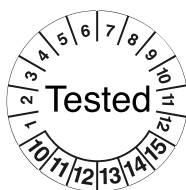

Ø 25	255909	255911	255913	255915	255917	255919
Ø 35	255910	255912	255914	255916	255918	255920

Inspection Date Labels B-429

Tamper-evident Date Inspection Labels for tamperproof applications

Material: (B-429) Self-destructible polyolefin
Packaging: 1 card

Size	Labels per card
Ø 10	104 Labels per card
Ø 15	40 Labels per card
Ø 20	28 Labels per card
Ø 30	15 Labels per card

Other sizes are available on request



	10	11	12	13	14	15	16	17	18
Ø 10 mm	224032	806228	806229	806230	806231	806232	806301	813102	813106
Ø 15 mm	224033	806233	806234	806235	806236	806237	806302	813103	813107
Ø 20 mm	224034	806238	806239	806240	806241	806242	806303	813104	813108
Ø 30 mm	224035	806243	806244	806245	806246	806247	806311	813105	813109



	2010	2011	2012	2013	2014	2015	2016	2017	2018
Ø 10 mm	224036	806248	806249	806250	806251	806252	806304	813110	813114
Ø 15 mm	224037	806253	806254	806255	806256	806257	806305	813111	813115
Ø 20 mm	224090	806258	806259	806260	806261	806262	806306	813112	813116
Ø 30 mm	224091	806263	806264	806265	806266	806267	806312	813113	813117



Ø 20 mm	806293	806268	806269	806270
Ø 30 mm	806294	806272	806273	806274



Ø 20 mm	806271	806309	813118
Ø 30 mm	806275	806310	813119

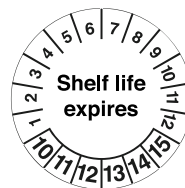
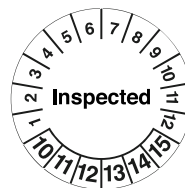
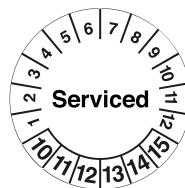
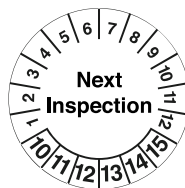
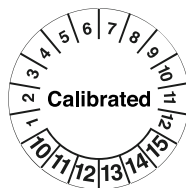
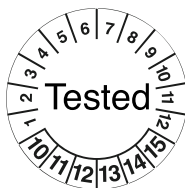

Ø 20	255994	255996	255998	255921	255923	255925
Ø 30	255995	255997	255999	255922	255924	255926



Hole Punch

Ideal to punch expire date labels.

- Made of superior quality nickel-plated steel.
- Punches documents of up to 1.5 mm thick.
- The design of the pair of tongs (50 mm wide) enables you to punch the middle of cards of up to 100 mm wide.
- A range of over 40 shapes and characters allow easy identification of all the people performing the inspection.

Symbols, numbers and letters available upon request



Order Ref.	Description	Shape
275065	Triangular hole punch	△
225053	Round hole punch	○
225054	Square hole punch	□

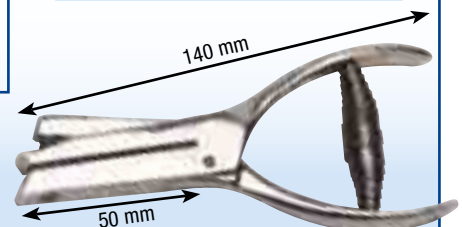

Quality Control

Label Dimensions: 38.00 mm x 16.00 mm
Labels per card: 14
Card dimensions: 50.80 x 228.60 mm
Packaging: 25 cards

REJECTED DATE _____
REASON _____
BY _____

SCRAPPED
DATE _____
INITIALS _____

CHECKED
BY _____
DATE _____

ACCEPTED
BY _____ DATE _____

Material	Order Ref.	Order Ref.	Order Ref.	Order Ref.
Vinyl Cloth	035001	256013	256028	035002
Polyester	-	-	-	035602
Aluminium Foil	035101	-	-	035102

TESTED
DATE _____ INITIALS _____

CERTIFICATION
BY _____ DATE _____
DUE _____

INSPECTED BY:
DATE _____

RE-WORK DATE _____
BY _____
REASON: _____

Material	Order Ref.	Order Ref.	Order Ref.	Order Ref.
Vinyl Cloth	035038	035042	035052	256012

Inventory

Label Dimensions: 38.00 mm x 13.00 mm
Labels per card: 18
Card dimensions: 50.80 x 228.60 mm
Packaging: 25 cards

STOCK NO.

SERIAL NO.

PROPERTY TAG
ASSET NO. _____

TOOL NO. DEPT. _____

Material	Order Ref.	Order Ref.	Order Ref.	Order Ref.
Vinyl Cloth	035037	035034	-	-
Aluminium Foil	035134	035129	035139	

Label Dimensions: 57.00 mm x 25.00 mm
Labels per card: 9
Card dimensions: 70.00 x 229.00 mm
Packaging: 25 cards

INVENTORIED DATE _____
STOCK NO. _____
COUNT _____
BY _____ CHECKED _____

Material	Order Ref.
Vinyl Cloth	035026



Pens

Order Ref.	Description	Colour	Packaging
335091	Fine	Black	1
335092	Ultra Fine	Black	1
055508	Fine (solvent based)	Black	1
055500	Ultra Fine (solvent based)	Black	1

Write-on Labels

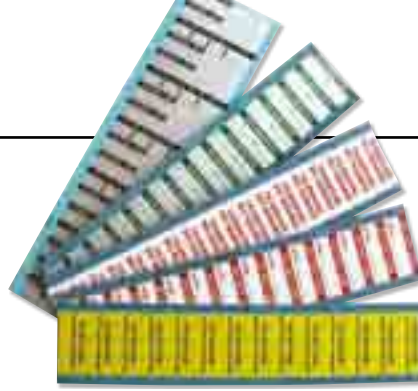

Maintenance

Label Dimensions: 38.00 mm x 16.00 mm
Card dimensions: 50.50 x 228.60 mm
Labels per card: 14
Packaging: 25 cards

DATE INSTALLED	
BY _____	DATE _____

REPAIRED BY	
INITIALS _____	DATE _____

CAUTION	
TEMPERATURE _____ °C	

DO NOT USE	
AFTER _____	

Material	Order Ref.	Order Ref.	Order Ref.	Order Ref.
Vinyl Cloth	035017	035031	035013	035018
Polyester	-	035631	-	-
Aluminium Foil	035117	-	-	035118

Label Dimensions: 57.00 mm x 25.00 mm
Card dimensions: 70.00 x 229.00 mm
Labels per card: 9
Packaging: 25 cards

SERIAL NO.			
MODEL NO.			
VOLTS	AC-DC	AMPS	HERTZ

Material	Order Ref.
Vinyl Cloth	235075



Pens



Order Ref.	Description	Colour	Packaging
335091	Fine	Black	1
335092	Ultra Fine	Black	1
055508	Fine (solvent based)	Black	1
055500	Ultra Fine (solvent based)	Black	1

Calibration

Label Dimensions: 38.00 mm x 16.00 mm
Card dimensions: 50.50 x 228.60 mm
Labels per card: 14
Packaging: 25 cards

CALIBRATION	
BY _____ DATE _____	
DUE _____	

CALIBRATED	
BY _____ DATE _____	
DUE _____	

DO NOT USE	
Until Tested & Calibrated	

Material	Order Ref.	Order Ref.	Order Ref.
Vinyl Cloth	035010	035041	035051
Aluminium Foil	035110	-	-

Label Dimensions: 38.00 mm x 13.00 mm
Card dimensions: 50.80 x 228.60 mm
Labels per card: 18
Packaging: 25 cards

CALIBRATION NOT REQUIRED	
--------------------------	--

Material	Order Ref.
Vinyl Cloth	035053
Aluminium Foil	035153

Label Dimensions: 38.00 mm x 13.00 mm
Card dimensions: 50.80 x 228.60 mm
Labels per card: 18
Packaging: 25 cards

CALIBRATED	
EXPIRES _____	
IDENT. NO. _____	
ACCURACY _____	
DATE CAL. _____	
BY _____	
DEPT. NO. _____	

Material	Order Ref.
Vinyl Cloth	035063

Blank Write-On Labels

Packaging: per pack of 25 cards

B-500 White Vinyl Cloth Order Ref.	B-619 White Polyester Order Ref.	B-184 Aluminum Foil Order Ref.	Labels per card	Label Size mm	Card Size mm
035016		035116	6	38.10 x 38.10	50.80 x 228.60
035019		035119	9	38.10 x 25.40	50.80 x 228.60
035024*		035124	14	38.10 x 15.88	50.80 x 228.60
035030		035130	20	38.10 x 11.10	50.80 x 228.60
035035		035135	25	38.10 x 8.71	50.80 x 228.60
035046	035646	035146	36	38.10 x 6.35	50.80 x 228.60
035047			72	19.05 x 6.35	50.80 x 228.60
035048			54	12.70 x 12.70	50.80 x 228.60
035049			18	38.10 x 12.70	50.80 x 228.60
035050			36	12.70 x 19.05	50.80 x 228.60
035054			4	57.15 x 57.15	69.85 x 228.60
035055			5	57.15 x 44.45	69.85 x 228.60
035056		035156	6	57.15 x 38.10	69.85 x 228.60
035059		035159	9	57.15 x 25.40	69.85 x 228.60
035062*		035162	12	57.15 x 19.05	69.85 x 228.60
035068		035168	18	57.15 x 12.70	69.85 x 228.60

* Only available in yellow

Blank Write-On Labels in Books

Material: B-500 vinyl cloth

Packaging: per book

Order Ref.	Colour	Label size mm	Labels/ Book
101950	Yellow	20.00 x 8.00	840
101915	Yellow	15.00 x 9.00	700
101952	Yellow	19.00 x 11.00	440
101953	Yellow	38.00 x 11.00	220

Blank Write-On Labels on Sheets

Material: B-500 vinyl cloth

Packaging: 25 sheets

Order Ref.	Colour		Labels per Sheet	Label size mm
	Black Border Yes	No		
101816	101803	Yellow	270	8.00 x 20.00
101817	101804	Yellow	324	9.00 x 15.00
101815	-	White	69	10.00 x 65.00
101807	101805	Yellow	189	11.00 x 19.00
101811	-	White	189	11.00 x 19.00
101890	-	Yellow	126	11.00 x 28.00
101808	101806	Yellow	80	11.00 x 38.00
101812	-	White	80	11.00 x 38.00
101813	-	White	68	14.00 x 42.00
101809	235083	Yellow	30	22.00 x 56.00
101814	-	White	30	22.00 x 56.00
101810	-	Yellow	21	35.00 x 60.00

Maintenance & Service Labels

Material: B-619 self-adhesive polyester

Size: 40 x 95 mm

Packaging: 1 card – 4 labels/card

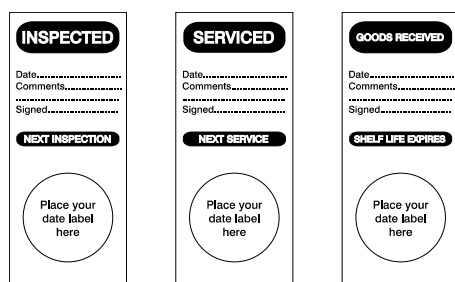

Order Ref.	Order Ref.	Order Ref.
256900	256901	256902

Inspection Placards

Material: B-619 self-adhesive polyester

Size: 100 x 150 mm

Packaging: pack of 10 labels

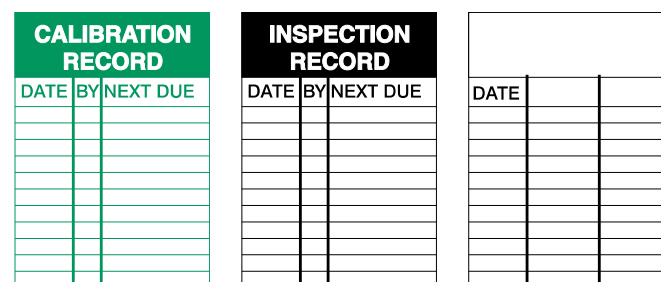

Order Ref.	Order Ref.	Order Ref.
256906	256907	256910

Write-on Tags

Material: Polyester (B-870), resists well to oil, grease, water, etc. Can be completed by using any pen.
Packaging: pack of 10 tags + one cable tie per tag.

Equipment Inspection Tags

Size: 100 x 175 mm

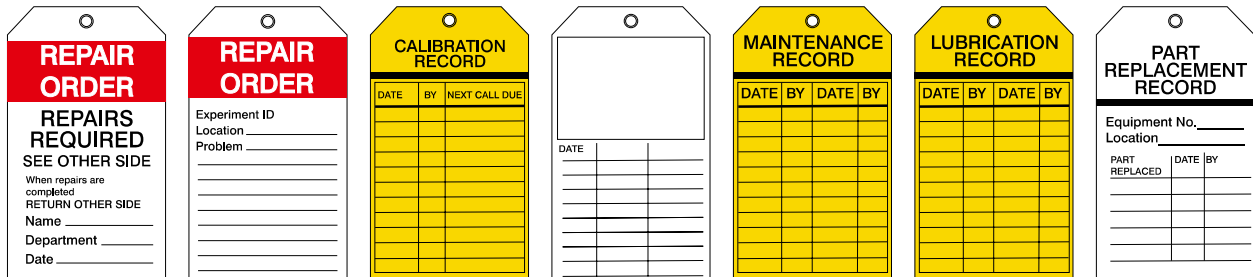

Order Ref.	256500	reverse	256504	256507	256508	256509	256510
------------	--------	---------	--------	--------	--------	--------	--------

Quality & Material Control Tags

Size: 75 x 150 mm

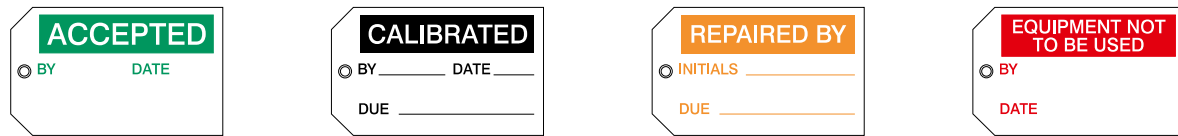

Order Ref.	256512	256513	256517	256518
------------	--------	--------	--------	--------



Order Ref.	256537	230390	230391	256545
------------	--------	--------	--------	--------



Order Ref.	256549	256551	256553	256561
------------	--------	--------	--------	--------



Pens

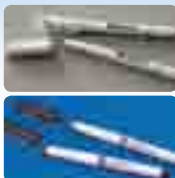

Order Ref.	Description	Colour	Packaging
335091	Fine	Black	1
335092	Ultra Fine	Black	1
055508	Fine (solvent based)	Black	1
055500	Ultra Fine (solvent based)	Black	1



Coloured Nylon Ties

Size: 200 mm x 4 mm
Material: nylon
Packaging: 100 pieces

Order Ref.	Colour
229955	White
229956	Blue
229957	Red
229958	Orange
229959	Yellow
229960	Green
229961	Violet
229962	Black





AREA MARKING

Photoluminescent Area Marking

Arrow tapes	138, 141
Warning tapes	138, 141
Light Clip arrows	138
Footprints	139
Arrows	139, 140
Dots	139, 140
Door handle backgrounds	139
Stair markers	140
Warning tapes & strips	141
Door marking tapes & strips	141

Anti-Skid Products

Anti-skid strips	141
Roll-mounted tape	142
Die-cut cleats	142
Reflective & glow-in-the-dark die-cut cleats	142
Hazard marking die-cut cleats	142
Striped tape	142

Tapes

Barricade tape	143
Graphic barricade tape	143
Tape dispensers	143
Super strong barricade tape	144
Flagger tape	144
Underground warning tape	144
Warning tapes	145
Aisle marking tapes	145
Durable marking tape	145
Reflective Stripes & Solid Colour Tapes	145
Warning tape with legend	146
Warning panel	145

Aisle Marking Products

Dots	146
Footprints	146
Removable footprints	146
Arrows	146

Warning Posts & Chains

Bradylink® warning post & chain	147
Brady connecting hooks	147
Brady connecting links	147
Brady warning posts	148
Message sign	148
Link	148
Brady Boys	148
Bradycone™ warning system	149
Economy floor stands	149
Heavy duty floor stands	149

Safety Bumpers

Polyurethane safety bumpers	150
Self-adhesive safety bumpers	150

Photoluminescent Area Marking



Brady offers a wide range of photoluminescent products. These indicate danger zones, even in complete darkness. In case of an emergency, these products will help your employees to find their way out of a dark room. For more information on photoluminescent safety signs, see the Safety Signs section in this catalogue.



BRADY
PHOTOLUM PRODUCTS

BradyGlo™ 10+ hour material exceeds these standards:

- IMO Resolution A . 752
- DIN 67 510

Glow-In-The-Dark Arrow Tapes

- BradyGlo™ arrow B-324 tapes exceed standard specifications.
- Designed for safe Low Location Lighting egress pathway marking during power outages and emergency situations.
- Two sizes available: 50 mm and 75 mm.
- Two directional graphic styles available: V and Arrow.

Material: Surface printed polyester (B-324)

Standard package: 1 roll (4.5 m).



Use BradyGlo™ tapes for visible marking at night or low light conditions.



V-Style

Order Ref.	Width
090971	50 mm
090972	75 mm



Arrow-Style

Order Ref.	Width
090973	50 mm
090974	75 mm



Glow-In-The-Dark Warning Tapes

- Self adhesive photoluminescent warning tape.

Material: Self adhesive polyester

Standard Package: 1 roll (9 m)

Order Ref.	Width
224071	25 mm
224072	50 mm



Light Clip Arrows

The Lite Clip is a glow-in-the-dark safety way guidance system that fixes onto tube lighting casings. The translucent Lite Clips almost go unnoticed in normal conditions. However when the lights are off, for example during a power cut or when visibility is poor due to the smoke from a fire, the Light Clip glows to indicate the shortest way to an emergency exit.

Standard Package: 10 arrows

Size: 180 x 120 mm

Order Ref.	Description
224199	Photoluminescent Arrow

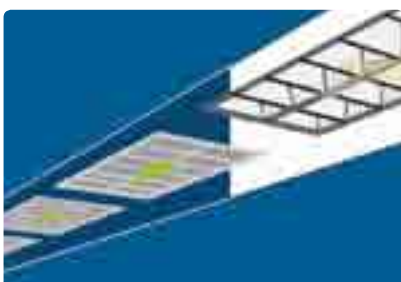

Perfect for: public buildings, offices, factories, warehouses, underground train stations, universities, parking areas, cruise ships, ferries...



Glow-In-The-Dark Footprints

Material: Photoluminescent Polyester (B-324)

Size: 30 cm

Standard Package: 1 foot

Order Ref.	Foot
055358	Left
055359	Right



Glow-In-The-Dark Arrows

Material: Photoluminescent Polyester (B-324)

Size: 75 mm

Standard Package: 100 arrows

Order Ref.
093275



Glow-In-The-Dark Anti-Skid Footprints

Material: Photoluminescent self-adhesive with anti-slip effect.

Size: 21 x 8.5 cm

Standard Package: 1 foot

Order Ref.	Foot
224074	Left
224073	Right



Glow-In-The-Dark Anti-Skid Floor Marking Dots

Material: Photoluminescent self-adhesive with anti-slip effect

Diameter: 50 and 95 mm

Standard Package: 10 dots

Order Ref.	Size
224077	50 mm
224078	95 mm



Door handle backgrounds

Material: Green/Photoluminescent, self-adhesive.

Size: 10 x 25.5 cm

Standard Package: 1 background

Order Ref.	Direction
224075	Left turn
224076	Right turn

Photoluminescent Area Marking



Photoluminescent individual dots (Self-adhesive)

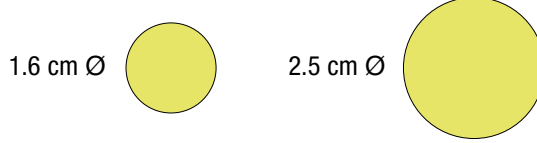

Part No.	Description	Diameter
263382	Photoluminescent dots – 40 dots/card	1.6 cm
263383	Photoluminescent dots – 15 dots/card	2.5 cm



Photoluminescent individual arrows (Self-adhesive)

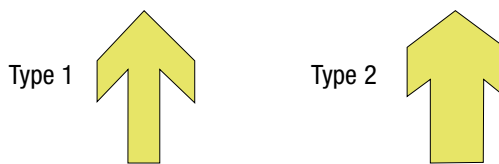

Order Ref.	Description	Size
263384	Arrows: type 1 – 20 arrows/card	1.8 x 2.7 cm
263385	Arrows: type 2 – 20 arrows/card	1.8 x 2.7 cm

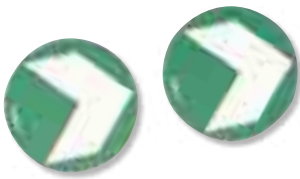

Photoluminescent Floor Marking Arrows (self-adhesive)

Order Ref.	Description	Size
263387	Aluminium dots HI (10 pcs)	9.5 cm



Photoluminescent Arrows – Rectangular (self-adhesive)

Order Ref.	Description	Size
251920	Floor arrow with anti-skid top (10 pcs)	17.5 x 11 cm
251921	Wall arrow (10 pcs)	17.5 x 11 cm



Photoluminescent Stair Marking

These markers have an anti-skid coating and indicate clearly the edges of stairs in the dark.

Order Ref.	Description	Size
251949	Photoluminescent stair marking	50 x 200 x 38 mm



Warning Tape: Standard Luminous Intensity

Standard Package: 1 roll

Red/Photolum. Striped Right Order Ref.	Left Order Ref.	Size
263366	263367	30 mm x 12 m
263368	263369	30 mm x 25 m
263370	263371	60 mm x 12 m
263372	263373	60 mm x 25 m

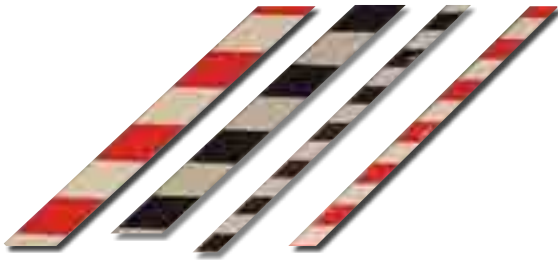

Photoluminescent Warning Strips

Self-adhesive aluminium warning strips with a high luminous intensity.

Standard Package: 1 strip

Red/Photolum. Striped Right Order Ref.	Black/Photolum. Striped Right Order Ref.	Size
251942	251936	100 x 3 cm
251944	251938	100 x 6 cm

Green Arrow Tape – Standard Photoluminescent Quality



Standard Package: 1 roll

Order Ref.	Size
263374	30 mm x 12 m
263375	30 mm x 25 m
263376	60 mm x 12 m
263377	60 mm x 25 m

Green Arrow Strips – High Photoluminescent Quality



Standard Package: 1 strip

Order Ref.	Size
251945	100 x 3 cm
251946	100 x 6 cm

Photoluminescent Door Marking Tape



Standard Package: 1 roll

Order Ref.	Size
263378	30 mm x 12 m
263379	30 mm x 25 m
263380	60 mm x 12 m
263381	60 mm x 25 m

Photoluminescent Door Marking Strips

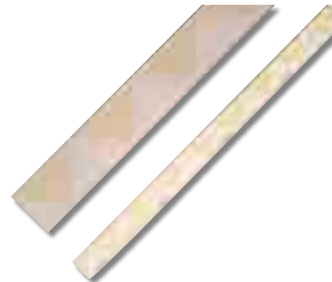

Standard Package: 1 strip

Order Ref.	Size
251947	100 x 3 cm
251948	100 x 6 cm

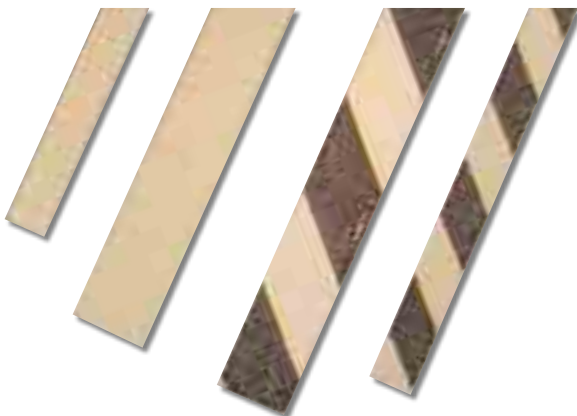

Photoluminescent Anti-skid Strips

These self-adhesive aluminium anti-skid strips are ideal for marking the edges of stairs and doorways. They are available in a standard luminous intensity version and a high luminous intensity version.

Standard Package: 1 strip

Order Ref.	Description	Size
251925	Aluminium Standard intensity	80 x 3 cm
251926	Aluminium High intensity	80 x 3 cm
251927	Aluminium Standard intensity	80 x 5 cm
251928	Aluminium High intensity	80 x 5 cm
251929	Aluminium Standard intensity/Striped	80 x 3 cm
251930	Aluminium High intensity/Striped	80 x 3 cm
251932	Aluminium High intensity/Striped	80 x 5 cm

Anti-Skid Products



Roll-Mounted Anti-Skid Tape

Anti-Skid tape helps to prevent slipping and falling on wet or slippery floors. The rugged polyester tape is adhesive backed and coated with thousands of particles of durable aluminium oxide grit.

- Bonds permanently to clean, dry floors.
- Works indoors or outdoors.
- Withstands grease and oil.
- Eliminates masking clean-up and drying time.

Length: 18 m
Standard Package: 1 roll

Width					Colour
25 mm	50 mm	100 mm	150 mm	300 mm	
Order Ref.	Order Ref.	Order Ref.	Order Ref.	Order Ref.	
078189	078190	078191	078193	078194	Black
	078091	078092			Yellow
078197	078198	078199			Brownish Red
	078187				White/grey
	078188				Clear
	078183				Fluorescent Yellow
	078182				Fluorescent Green
	078184				Fluorescent Orange



Anti-Skid Tape-Die-Cut Cleats

Installation is easy, just peel off the protective liner and press in place.

Material: Adhesive backed plastic cleat

Standard package: 50 cleats

Order Ref.	Size mm.	Colour
078192	19 x 600	Black
078195	150 x 600	Black
078196	140 x 140	Black
078177	140 x 140	Red



Reflective & Glow-in-the-Dark Die-Cut Cleats

Provides an extra margin of safety at night, during blackouts or in low light conditions.

Standard Package: 24 cleats

Order Ref.	Description	Size mm.
078161	Reflective	150 x 600
078162	Glow-in-the-dark	150 x 600



Anti-Skid Tape/Hazard Marking Die-Cut Cleats

The Anti-skid tape provides traction on slick floors, while the printed message signals a visual warning.

Standard Package: 24 cleats

Order Ref.	Legend	Size
078160	Caution	15 cm x 60 cm
078163	Watch your step	15 cm x 60 cm



Striped Anti-Skid Tape

This bright yellow and black striped Anti-Skid Tape aids visibility.

Material: Adhesive backed plastic tape, oxide grit coated.

Standard Package: 1 roll (18 m)

Colour: Black/Yellow

25 mm	50 mm	75 mm	100 mm	150 mm
Order Ref.	Order Ref.	Order Ref.	Order Ref.	Order Ref.
078146	078147	078148	078149	078150



Barricade Tapes

Visual barricading provides fast on-the-spot warning of potential dangers. The non-adhesive tape can be used for temporary outdoor or permanent indoor applications. This tape can be tied, stapled or nailed to posts, fences or metal barricades.

Material: polyethylene

Thickness: 0.075 mm

Size: 75 mm x 250 m

Standard Package: 1 roll

Ord. Ref.	256650	256651	256652	256653	256654
Ord. Ref.	256659	256660	256860	256861	256858
Ord. Ref.	256859	Striped Barricade tape Size: 75 mm x 500 m – Thickness: 0.03 mm Temporary Danger Permanent Danger Ord. Ref. 291426 291425			

Graphic Barricade Tapes

Combined text and graphics re-enforce your message immediately.

- Highly-visible and extremely durable.
- Supplied on handy spools enabling use over and over again.
- Weather-resistant 0.1 mm thick polyethylene.
- Each roll measures 76 mm x 305 m.

Graphic Baricade Tape Accessories:

Order Ref.	Description
702121	Fencing pins – pack of 10

Order Ref.	702123	702124	702125	702126	702127	702128
Order Ref.	702129	702130	702131	702132	702133	702134
Order Ref.	702135	702136	702137	702138	702139	702140
Order Ref.	702141	702142	702143	702144	702145	702146

Tape Dispensers

Durable yellow tape dispenser, features replaceable cutting blade (blades available on request). This dispenser can be used with any of the Brady barricade tapes and holds rolls up to 500 m long with a maximum width of 100 mm. Its design protects your tapes from dust and dirt.

Weight: 650 g

Size: 107 x 220 x 300 mm

Packaging: 1

Order Ref.
225000



This Tape dispenser holds 305 m long rolls of tape with a 75 mm width. It dispenses the tape quickly, safely and efficiently. Its features are:

- Lightweight, indestructible polypropylene construction.
- Advances the tape as required using your thumb.
- The steel safety cutting blade cuts fast and clean.
- The device can also be used with tapes of 50 mm.

Order Ref.
072412



Barricade Tape

Super strong Barricade Tape



Long-lasting hazard protection, even with long distances between tie points. Reinforced Barricade Tape is stronger than ordinary barricade tape, making long stretches between tie points easy. No stretch or sag in sunlight or wind and it's tough enough to be used again.

Width: 75 mm
Length: 100 m
Standard Package: 1 Roll



Ord. Ref. 240089



240098



Ord. Ref. 240099



091104



256868



Flagger Tape

Tug each end of the strong barrier tape to allow strips to detach and hang down giving a greater visual warning than with conventional barrier tape.

Size: 75 mm x 0.04 mm x 250 m
Colour: Red/White
Packaging: 1

Order Ref. 225004

Underground Warning Tape

Underground tape is buried 30 to 45 cm below ground level. Digging crews receive warning of buried lines and cables, allowing a margin of safety between the tape and the buried line.

- Easily Seen
- Easily Identified - by means of colour coding
- Convenient - Handy dispensing reel.
- Strong - Heavy duty polyethylene material resists acid, alkalis and other soil substances. Tape is 0.1 mm thick, with a tough tensile strength of 1750 psi.
- Long Lasting - Coated graphics provide long lasting legibility and hold colour values.
- Economical - Compared to the potential cost of line damage, this tape is cost-effective for use over the entire length of the line.

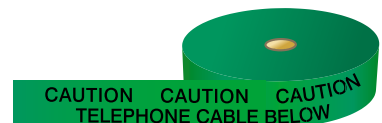
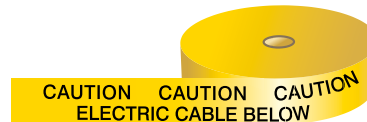

Order Ref.	Utility Class	Size (W x L)	Colour
256862	Electric cable below	150 mm x 365 m	Yellow
256865	Water pipe below	150 mm x 365 m	Blue
256864	Telephone cable below	150 mm x 365 m	Green



The markings of transport routes must be both flexible and durable, as they are constantly adapted to the changing demands and needs within your factory or warehouse. BRADY floor marking products are an economical solutions for marking the routes and and potentially hazardous areas inside your factory quickly and easily. Brady area marking tapes stand up to the toughest conditions.

Locked in colours • Permanent adhesive • Easy application • Bold patterns • Flexible tape



Warning Tapes

- Self-adhesive warning film for marking pillars, pylons, the edges of walls, gate arches and lifts.
- Extremely durable (0.138 mm thick).
- Waterproof, oil, alkali and acid resistant.
- 3 colours.
- Three widths.

Material: self-adhesive PVC

Roll length: 33 m

Standard pack: 1 roll

Order Ref.	Short Description	Width (mm)	Colour
255311	WS8V - YL/BK	38	
255312	WS8V - YL/BK	50	
255313	WS8V - YL/BK	75	
255295	WS8V - RD/WT	38	
255296	WS8V - RD/WT	50	
255297	WS8V - RD/WT	75	
225001	WS8V - GR/WT	38	
225002	WS8V - GR/WT	50	
225003	WS8V - GR/WT	75	

Aisle Marking Tapes

- Long lasting
- Sticks tightly to surfaces
- Easy to use
- Available in a wide range of colours

Material: Self-adhesive vinyl (B-726)

Length: 33 m

Standard package: 1 roll



Yellow Order Ref.	Red Order Ref.	Green Order Ref.	White Order Ref.	Blue Order Ref.	Black Order Ref.	Width
058200	058201	058202	058203	058220	058222	50 mm
058250	058251	058252	058253	058221	058223	75 mm

Durable Marking Tape

Colours are sealed beneath a protective layer of abrasion resistant clear laminate. Aggressive adhesive holds on almost any clean, dry surface. Markings stand up to toughest conditions - indoors or out.

Material: Self-adhesive vinyl (B-950)

Standard Package: 1 roll

Length: 16.5 m



				Width
Order Ref.	Order Ref.	Order Ref.	Order Ref.	
055300	055294	055290		25 mm
055301	055295	055291	055312	38 mm
055302	055296	055292	055313	50 mm
055303	055297	055293	055314	75 mm



Reflective Stripes & Solid Colour Tapes

These tapes give an extra margin of safety during blackouts, at night, or in low light conditions.

Material: Reflective Adhesive Material (B-957)

Length: 4.5 m

Standard Package: 1 roll



Solid Colour Tape

Order Ref.	Order Ref.	Order Ref.	Width
078985	078986	078989	50 mm
078987	078988	078990	75 mm

Stripes

Order Ref.	Order Ref.	Order Ref.	Width
076308	076309	076310	50 mm
076312	076313		75 mm

Marking Tape / Aisle Marking Products



Warning Panels

These self-adhesive warning films made from vinyl in black on yellow are designed to give early warning about trucks, loading platforms, posts and fork-lift trucks. They can be used wherever there are potential dangers to the work force.

Material: Self-adhesive vinyl (B-946)



Order Ref.	Description	Size mm	Colour	Panels per pack
055318	WP-516Y	142 x 428	Yellow/Black	10
055319	WP-1116Y	286 x 428	Yellow/Black	10
255322	WP-1116RD	286 x 428	Red/White	10



Vinyl Dots

Self-adhesive Aisle Marking Dots are perfect for marking short aisles, or around machines, equipment and storage areas.

Material: Self-adhesive vinyl (B-933)

Standard Package: 500 dots



Yellow Order Ref.	Red Order Ref.	Green Order Ref.	White Order Ref.	Size (mm)
055324	055337	055342	055347	50 mm
055325	055338	055343	055348	75 mm
055326				100 mm
055327				125 mm



Vinyl Footprints

Material: Self-adhesive vinyl (B-933)

Size: 30 cm

Standard Package: 1 footprint



Yellow Order Ref.	Red Order Ref.	Green Order Ref.	White Order Ref.	Foot
055356	056922	056920	056924	Left
055357	056923	056921	056925	Right



Removable Footprints

Durable, skid-resistant footprints with removable back

Material: Self-adhesive vinyl (B-933)

Size: 30 cm

Standard Package: 10 footprints = 5 left / 5 right



Yellow Order Ref.	Red Order Ref.	Green Order Ref.	Blue Order Ref.
031550	031553	031551	031552



Vinyl Arrows

Material: Self-adhesive vinyl (B-933)

Standard Package: 100 arrows



Yellow Order Ref.	Red Order Ref.	Green Order Ref.	White Order Ref.	Size (mm)
055352	056918	056914	056916	50 mm
055353	056919	056915	056917	75 mm
055354				100 mm
055355				125 mm



Bradylink® Warning Post & Chain

Barricade potentially hazardous areas indoors or outdoors with portable plastic posts and chains. Their lightweight yet tough construction stands up to years of use in temporary or permanent applications.

The components of the posts and chains are made of polyethylene with the following features:

- **Non-conductive:** Can be safely used in electrically hazardous areas.
- **Built-in Ultraviolet Inhibitors:** Screen out the sun's rays to prevent colours from fading during outdoor use.
- **Light Weight:** chain is lighter than similar metal parts – chain weights 2.7 kg per 25 metres
- **Non-Rusting:** Unlike metal posts and chain Bradylink, plastic parts cannot rust.
- **Fillable Base:** Hollow base can be filled with water or sand for more stable application.
- **C-Hook:** Large C-Hook holds chain in place. Use open, or closed for greater security.

Post Diameter: 75 mm

Base Dimensions: 40 cm diameter

Height: 1.04 m.



Box of 1* Order Ref.	Box of 6* Order Ref.	Post Colours
092116	092119	Black
092117	092120	White
092118	092121	Yellow
092122	092123	Striped Black/Yellow
092124	092125	Striped Black/Yellow Reflective

*Bases and tops included. Links and chain NOT included

Replacement Bases & Tops

Standard package: 1 piece

Bases Order Ref.	Tops Order Ref.	Colours
092128	092131	Black
092129	092132	White
092130	092133	Yellow



- Insert post into base and turn into place. Base may be filled with sand or water to make the assembly more stable.
- Drop C-Hook into slots, insert post to, and screw into place. Large C-hook holds chain in place.

Brady Warning Chain

Material: Polyethylene.

Standard Package: 25 m (2.7 kg)

Order Ref.	Colour
278271	Yellow
278268	White
278269	Red/White
278270	Black/Yellow

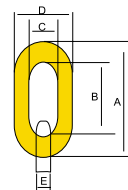

Dimensions
A: 50,8 mm
B: 36,5 mm
C: 17,4 mm
D: 30,1 mm
E: 7,3 mm



Brady Connecting Hooks

Material: Polyethylene

Standard Package: one bag of 36 pcs.

Usage: attaching lengths of chains

Yellow Order Ref.	White Order Ref.	Black Order Ref.	Size
078255	078256	-	38 mm
078257	078258	078259	50 mm



Brady Connecting Links

Material: Polyethylene

Standard Package: one bag of 36 pcs.

Usage: for a more permanent application or repairing chain links, these connecting links can be used

Yellow Order Ref.	White Order Ref.	Black Order Ref.	Size
078244	078245	-	38 mm
078246	078247	078248	50 mm



Warning Posts & Chains

Warning Posts

Ideal for controlling and directing foot traffic. Suitable for warehouses, factories, offices, etc.

Chains and ribbons can be attached to the sturdy 90 cm high posts. The posts are available in one-colour or two-colour versions (stripes of 10 cm wide).

- **Material:** polyethylene
- **Non-conductive:** the posts can be used for barricading electrically hazardous installations
- **Built-in ultraviolet inhibitors:** block out ultraviolet rays to prevent colours from fading
- **Colours:** they stay bright and eye-catching, even after years of use
- **Sizes:** height: 90 cm, outside diameter: 6 cm

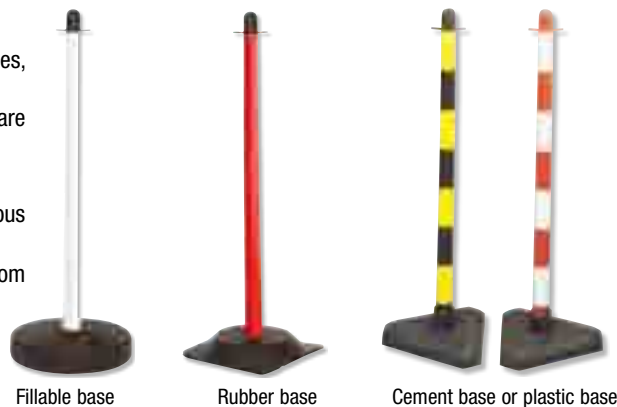

Red Order Ref.	Red/White Order Ref.	Yellow/Black Order Ref.	White Order Ref.	Description	Height
256729	256721	256722	256725	Post & fillable base (4 pcs.)	90 cm
256730	256723	256724	256726	Post & rubber base (4 pcs.)	90 cm
292234	292237	292236	292239	Post & cement base (4 pcs.)	90 cm
292233	292238	292240	292235	Post & triangular plastic base (no cement)	90 cm
292244	292242	292241	292243	Post & top (no base)	
292248		292247	292249	Top	

Order Ref.	Description	Size	Height
256727	Fillable base only (1 pc)	Ø 25 cm	12 cm
256728	Rubber base only (1 pc)	side: 27 cm	
292246	Cement base only (1 pc)	side: 29 cm	
292245	Triangular plastic base only (empty - no cement) (1 pc)	side: 29 cm	



Message sign

Create an even safer work environment by using these universal signs.

The plastic frame simply clips to the Brady posts.

Comes as a complete kit: frame + 2 attachment clips + 1 chain (black, 20 cm)

Colour: black

Sizes: A4 or A5

Packaging: 1

Order Ref.	Description
292250	Kit A4



Link

This yellow rubber link enables you to attach a second chain to your posts.

Packaging: 1 pack of 20

Order Ref.
292252



The Brady Boys

Interlocking at their hands and feet, the Brady Boys offer an attractive alternative for barricading hazardous areas.

Height: 105 cm

Thickness: 25 mm

Width: 79 cm

Standard package: 2 Brady Boys

Weight: 2.5 kg

Order Ref.	Legend
092270	Caution ... out of service
292270	Blank



Bradycone™ Warning System

- 4-sided visual cautions eliminate blind areas.
- Lock-in signs provide warning for specific problems.
- Lock-in safety lights for use in darkened areas.
- Lock-in chains and barrier panels to control pedestrian traffic.
- Easy stacking for storage.
- High impact, weather-resistant materials for indoor/outdoor use.

Cones

Order Ref.	Description	Height
077198	Yellow cone, blank	63 cm
077200	Yellow cone, "Wet floor" (on cone)	63 cm
077199	Orange cone, blank	63 cm
077205	Yellow cone, blank	89 cm
077202	Yellow cone, "Wet floor" (on cone)	89 cm
077204	Orange cone, blank	89 cm

Accessories

Order Ref.	Product	Description
077210	Lock-in sign frame	Black, 25 cm height (when attached), 21 x 21 cm face
256717	Lock-in frame + sign	Frame + "NO ADMITTANCE" sign
256719	Lock-in frame + sign	Frame + "NO SMOKING" sign
077206	Safety light	Flashes up to 200 hours on 2 "D" cell batteries (not included)
077207	Lock-in chain	Yellow, 6 m plastic link, locks directly into cone
077228	Weight ring	For 63 cm cone - 2.7 kg
077208	Weight ring	For 89 cm cone - 4 kg



256717



256719



Economy Floor Stands

- Printed on both sides –inside and out- offering two stands for the price of one.
- Lightweight corrugated polypropylene material measures 30 cm wide by 50 cm high (closed)

Standard package: 1 piece

Order Ref.	Description	Colour
256715	Blank economy stand	White
256716	Blank economy stand	Yellow

BRADY
Customize-it

Contact your Brady Specialist for more information on customized Economy Floor Stands

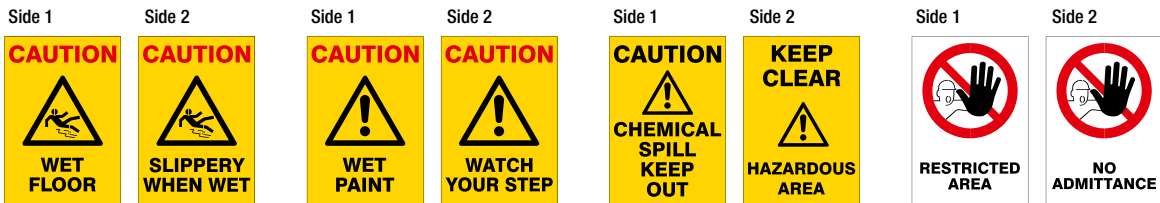

Order Ref.	256711	256712	092284	256714
------------	--------	--------	--------	--------



Heavy Duty Floor Stands

Easily transportable, these stands are very useful to carry with and clearly indicate substantial dangers such as slippery zones. They are ideal for hospitals or public halls for example.

- Heavy duty yellow high density polypropylene
- Height: 66 cm
- Maintenance free : will not dent or corrode
- Large message area is visible from over 9 meters

Available with a range of standard messages or as a blank stand.

Order Ref.	Description
092110	Blank heavy duty floor stand



Order Ref.	256709	256700	256701	256702	256704	256705	256706	256708
------------	--------	--------	--------	--------	--------	--------	--------	--------



Polyurethane Safety Bumpers

Clearly visible, made from polyurethane foam rubber, flexible and sturdy material, optimal shock-absorber.

- 4 colours: black; yellow on black; photoluminescent on black
- 3 models available + 2 corner connecting pieces
- The photoluminescent strips are coated with a film that protects against physical and chemical actions. In the dark, these products give off the light they have absorbed during the day.
- Non-toxic and non-radioactive
- Length: 1m.
- Secured with adhesive.

Packaging: 1

Order Ref.	Model	Colours
225010	A	Black
225011	A	Yellow/Black
225012	A	Photolum./Black
225015	B	Yellow/Black
225016	B	Photolum./Black
225018	C	Yellow/Black
225019	C	Photolum./Black
Order Ref.	Model	
225020	2-dimensional corner piece	

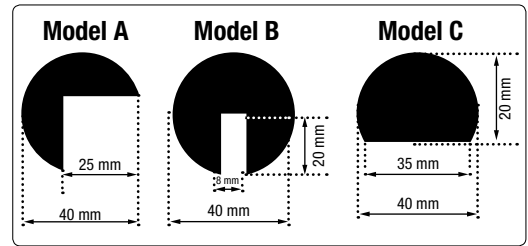

Self-adhesive Safety Bumpers

Protect corners and edges with these shock-absorbers.

- Shock-absorber made from cellular thermoplastic.
- Dual function: indicates hazardous situations and softens any impacts.
- Increases safety in the workplace.
- Highly resistant against hydrocarbons.
- Double-sided adhesive, can be attached to any clean surface
- Choice out of 3 models

Packaging: 10

Order Ref.	Model	Size (mm)
225022	Corner (a)	680 x 110 x 14
225023	Sleeve (b)	660 x 28 x 29
225024	Cover (c)	750 x 151 x 14

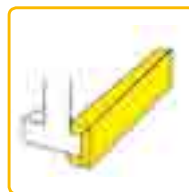
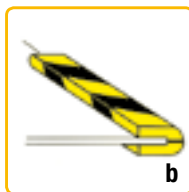
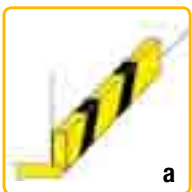



Brady has hundreds of RoHS compliant materials for you to choose from and we are committed to provide you with the latest information. Simply go to www.weerohs.bradyeurope.com for the latest up-date.

material	Material Description	Temperature range	Properties & applications
B-156	Foam tape adhesive coated	10°C to 82°C	White polypropylene tape, coated on both sides with high tack, high shear synthetic rubber adhesive for indoor & outdoor use. Excellent for placing safety signage.
B-208	Cold temperature mounting strips	-57°C to 65°C	Excellent for placing safety signage in cold temperatures
B-292	Vinyl	-40° to 60°C	Good conformability, and durability. Self-extinguishing.
B-324	Brady Glo tape	10°C to 110°C	Designed for low location lighting and safety way guidance marking during power cuts and emergency situations
B-446	Photoluminescent Vinyl	10°C to 110°C	Designed for low location lighting and safety way guidance marking during power cuts and emergency situations
B-455	PVC Sheet	-20° to 70°C	Surface printed sign material. Bends easily when heated and can be shaped into projecting signs, keeping the new shape until it cools down. Thickness; 1.5mm
B-500	Vinyl Cloth	-40° to 82°C	Moderately resistant to heat, oil & dirt. Repositionable
B-607	Vinyl	-40°C to 70°C	Tamper evident film with a permanent acrylic adhesive. Designed to fracture easily to prevent one-piece removal.
B-725	Vinyl	80°C maximum	Good conformability; dielectric strength. Used for aisle marking tapes
B-851	Polyester tag	-40°C to 100°C	Resistant to water, grease and extreme temperatures.
B-859	Magnetic material	80°C maximum	Magnetic material for pre-printed numbers & letters DIN A4 sized (210 x 297 mm)
B-912	Polyethylene	54°C maximum	Barricade tapes
B-915	Coiled plastic	-40°C to 60°C	Cylindrical coiled plastic sheets used for Brady Snap-On
B-916	Grit coated plastic film	-40°C to 100°C	Grit coated plastic film, used as indoor / outdoor anti skid tape, with a permanent pressure sensitive acrylic adhesive.
B-933	Vinyl	-40°C to 93°C	QUICK-ALIGN™ numbers & letters, floor marking
B-946	Vinyl	-40°C to 82°C	High gloss durable vinyl film with pressure sensitive adhesive. Used for Numbers & Letters for indoor use only.
B-950	Vinyl	10°C to 79°C	Suitable for use as warning tape.
B-957	Reflective Sheeting	-40°C to 70°C	Acrylic retroreflective sheeting with pressure sensitive adhesive. Used for area marking applications.
B-966	Polyester	-70°C to 120°C	Overlaminating tape
B-993	Vinyl	-40°C to 40°C	Removable numbering kit
B-997	Reflective	can be applied at -27°C	Numbers & Letters. Will perform despite storms, snow, humidity and other tough environmental conditions.
B-7520	Laminated linerless polyester	-40°C to 140°C	Surface printed polyester with a permanent pressure sensitive adhesive and overlaminated with a clear polyester film. Used for pipe marking & safety signs that require 5 to 8 years outdoor use.
B-7523	Aluminium	-40°C to 110°C	Photoluminescent Aluminium signs - standard photolum
B-7524	Aluminium	-40°C to 110°C	Photoluminescent Aluminium signs - high intensity photolum
B-7525	Aluminium	-40°C to 140°C	Aluminium safety sign protected with transparent polyester.
B-7527	Polypropylene	-40°C to 120°C	Good chemical resistance. Used for safety signs
B-7529	Polyester	-40°C to 120°C	Surface printed polyester with a permanent pressure sensitive adhesive and overlaminated with a clear polyester film making it resistant to 10 years outdoor use. Used for pipe marking & safety signs
B-7536	Polyester	140°C maximum	Rating plates, inventory control labels, warehouse and pipe marking.
B-7537	PVC	-30°C to 80°C	Photoluminescent IMO signs
B-7538	Polyester	-40°C to 120°C	Floor marking. Overlaminated with rubber based adhesive.
B-7539	Polyester	60°C maximum	Warehouse and racking identification. Removable adhesive.
B-7541	Laminated Polyester	-40°C to 140°C	Surface printed polyester with a permanent pressure sensitive adhesive and overlaminated with a clear polyester film. Used for pipe marking & safety signs that require 5 to 8 years outdoor use.
B-7548	Polyester	-20°C to 70°C	Surface printed polyester film with permanent acrylic adhesive overlaminated with a clear polyester film.
B-7609	PVC Tag	-40°C to 100°C	Flexible tag stock

Quantities per pack for numbers & letters



Combination Packs – page 124 (B-499)

Numbers			
Order Ref.	Number: Quantity	Number: Quantity	Number: Quantity
034052	0 to 5: 400 pcs	6 to 9: 300 pcs	
034152	0 to 5: 225 pcs	6 to 9: 150 pcs	
034252	0 to 5: 100 pcs	6 to 9: 50 pcs	
034352	0 to 9: 25 pcs		
034452	0 to 9: 25 pcs		
034552	0 to 1: 25 pcs	2 to 5: 15 pcs	6 to 9: 10 pcs
034652	1 to 5: 15 pcs	6 to 9 and 0: 10 pcs	
034752	1 to 5: 3 pcs	6 to 9 and 0: 2 pcs	



Letters				
Order Ref.	Letter: Quantity	Letter: Quantity	Letter: Quantity	Letter: Quantity
034051	A and E: 400 pcs	B: 300 pcs	C to D: 200 pcs	F to Z: 100 pcs
034151	A to Z: 75 pcs			
034251	A to F: 50 pcs	G to Z: 25 pcs		
034351	A to C and E: 17 pcs	D and F to J: 9 pcs	K to Z: 8 pcs	
034451	A to C and E: 17 pcs	D and F to J: 9 pcs	K to Z: 8 pcs	
034551	D and F to Z: 5 pcs	A to C and E: 10 pcs		
034651	B to D and F to Y: 5 pcs	A and E: 6 pcs	Z: 3 pcs	
034751	A to Z: 1 pc (26 cards/pack)			



Consecutive Markers – page 124 (B-499)

Order Ref.	Number/Letter: Quantity	Number/Letter: Quantity
034010	0 to 5: 400 pcs	6 to 9: 300 pcs
034138	A to Z: 75 pcs	
034110	0 to 5: 225 pcs	6 to 9: 150 pcs
034238	A to F: 50 pcs	G to Z: 25 pcs
034210	0 to 5: 100 pcs	6 to 9: 50 pcs
034340	A to J: 25 pcs	
034341	K to T: 25 pcs	
034342	U to X: 50 pcs	Y to Z: 25 pcs
034310	0 to 9: 25 pcs	
034440	A to J: 25 pcs	
034441	K to T: 25 pcs	
034442	U to X: 50 pcs	Y to Z: 25 pcs
034410	0 to 9: 25 pcs	



Combination Packs – page 125(B-946)

Numbers			
Order Ref.	Number: Quantity	Number: Quantity	Number: Quantity
097601	1 to 2: 150 pcs	0 and 3 to 5: 75 pcs	6 to 9: 50 pcs
097603	0 to 9: 25 pcs		
097605	0 to 9: 25 pcs		
097607	0 to 1: 25 pcs	2 to 5: 15 pcs	6 to 9: 10 pcs
097129	1 to 5: 15 pcs	6 to 9 and 0: 10 pcs	
097599	1 to 5: 3 pcs	6 to 9 and 0: 2 pcs	
806201	1 to 2: 150 pcs	0 and 3 to 5: 75 pcs	6 to 9: 50 pcs
806202	0 to 9: 25 pcs		
097711	1 to 5: 15 pcs	0 and 6 to 9: 10 pcs	



Letters			
Order Ref.	Letter: Quantity	Letter: Quantity	Letter: Quantity
097600	A to F: 50 pcs	G to Z: 25 pcs	
097602	A to C and E: 17 pcs	D and F to J: 9 pcs	K to Z: 8 pcs
097604	D and F to Z: 8 pcs	A to C and E: 16	
097606	D and F to Z: 5 pcs	A to C and E: 10	
097128	B to D and F to Y: 5 pcs	A and E: 6 pcs	Z: 3 pcs
097598	A to Z: 1 pc (26 cards/pack)		
806203	A to F: 50 pcs	G to Z: 25 pcs	
806204	A to C and E: 17 pcs	D and F to J: 9 pcs	K to Z: 8 pcs
097712	B to D and F to Y: 5 pcs	A and E: 6 pcs	Z: 3 pcs

10-year outdoor pipe markers	80	Cones	149
480-600V breaker lockout	99	Consecutive markers (numbers & letters)	124
A		Construction site safety signs	28
A3, A4 & A5 signs	41	Custom safety signs	63
Adjustable gate valve lockout	92	Cylinder tank lockout	96
Adjustable lockout stations	111	D	
Aisle marking tapes	145	Danger symbols on rolls	79
All purpose cable lockout	93	Date labels	131-132
Aluminium padlocks	106	Die-cut cleats (anti-skid)	142
Aluminium utility panels (numbers & letters)	127	Directional flow arrow tape	78
Anti-skid products	141-142	Door handle backgrounds (photoluminescent)	139
Anti-skid strips	141	Door marking tapes & strips (photoluminescent)	141
Area marking	137	Dots (photoluminescent)	139, 140
Arrow (Light Clip)	138	Dual lock	62
Arrow tapes (photoluminescent)	138, 141	Duffel bag (lockout)	113
Arrows (photoluminescent)	141, 142	Durable marking tape	145
Assembly signs	8	DVD: lockout tagout	87
Attachment chain	84	E	
B		Easy Number	127
Ball valve lockouts	90-91	Economy floor stands	149
Barricade tape	145	Economy lockout	109
Beaded chain	84	Economy multi-pole breaker lockout	98
Bin location labels	121	Electrical lockout kit	102
Blank magnetic strips	129	Electrical risk: lockout tagout	98
Blank safety lockout hasps	109	Electrical/pneumatic lockout	97
Blank write-on labels	135	Emergency escape signs	6
Blank write-on magnetic labels	129	Emergency exit signs	7
Brady ball valve lockout	91	Engraved valve tags	83
Brady Boys	148	Equipment inspection tags	136
Brady cable lockout device	94	European style pipe markers	70
Brady connecting hooks	147	Exit & assembly signs	8
Brady connecting links	147	Exit signs	8
Brady Customize-it tags	118	Explosive atmosphere signs	21
Brady Customize-it: custom safety signs	63	Extinguisher code signs	11
Brady safety padlocks	105	Extra large safety signs	66
Brady safety tags	116	Extra-large lockout station	111
Brady Snap-On™	79	F	
Brady steel padlocks	105	Fire action mandatory signs	12
Brady warning chain	147	Fire equipment signs	10
Bradycone™	149	Fire exit signs	6
Bradyfoam™ mounting tape	62	Fire extinguisher code signs	11
BradyGlo™	54	First aid signs	9
Bradylink®	147	Flagger tape	146
Bradyply	84	Floor safety signs	40
Brass I.D. tags	84, 107	Floor stands	149
Brass identification tags for valves	82	Footprints (photoluminescent)	139
Brass padlocks	106-107	Footprints	146
Breaker blocker kit	99	Fully insulated lock	107
Breaker lockouts	98-100	G	
British standard fire exit & emergency escape signs	6	Gas cylinder lockout	96
Butterfly valve lockout	95	Gate valve lockout kit	103
C		Gate valve lockouts	92-94
Cable	107	General safe condition & first aid signs	9
Cable lockouts	93-94	GHS Labels	52, 79
Cable ties	117, 136	Glow-in-the-dark anti-skid floor marking dots	139
Calibration write-on labels	134	Glow-in-the-dark anti-skid footprints	139
Chain (area marking)	147	Glow-in-the-dark arrow tapes	138
Circuit breaker lockouts	98-100	Glow-in-the-dark arrows	139
Clips	84	Glow-in-the-dark die-cut cleats (anti-skid)	142
Cobra cable	107	Glow-in-the-dark footprints	139
Cold temperature mounting strips	62	Glow-in-the-dark warning tapes	138
Coloured nylon ties	117, 136	Graphic barricade tape	143
Combination packs (numbers & letters)	124, 125	Group lock box	112

Index

Group lockout centre	112	Magnetic identification	128-130
H		Magnetic letters on a sheet	128
Harsh environment signs	29	Magnetic numbers & letters	128
Hasps	108-109	Magnetic numbers on a sheet	128
Hazard marking die-cut cleats (anti-skid)	142	Magnetic pouches	130
Hazard symbols on rolls	79	Magnetic signs (lockout/tagout)	118
Hazard warning diamond placards	48	Magnetic strips	62
Hazard warning signs	17	Magnetic strips: write-on/wipe-off	129
Hazardous substances identification	52	Maintenance & service labels	135
Heavy duty floor stands	149	Maintenance and quality tags	114
Heavy duty steel lockout	109	Maintenance record tags	117
Hole punch	132	Maintenance write-on labels	134
Hooks	84	Mandatory safety signs	13
Hooks (for chains)	147	Marine pipe marking	82
Hubbell plugout for industrial plug connections	97	Maritime transport signs	51
I		Material overview	151
Identical numbers or letters on one card	124, 125	Maxi-markers	80
IMO safety signs - BradyGlo™	54	Maximum chain security	107
Individual pipe markers with die cut arrowheads	70	Mechanical risk: lockout/tagout	90
Industrial strength lockout station	111	Message sign (area marking)	148
Information notices	33	Metal clips	84
Inspection date labels	131-132	Mini cable lockout	93
Inspection placards	135	Mini lockout starter kit	108
Inventory write-on labels	133	Miniature circuit breaker lockout	100
K		Mini-markers	80
Keying & charting options	104	Mini-pictograms	47
L		Mounting systems	62
Labelled safety lockout hasps	109	Mounting systems	62
Large electrical/pneumatic lockout	97	Multi-message signs	26
Large lockout pouch	113	N	
Large lockout station	111	NFPA placard	53
Large pouches with magnetic strips	130	No hole circuit breaker lockout	98
Legislation: pipe marking	68	Non-conductive ball valve lockout	91
Light Clip arrows	138	Non-conductive lockout hasp	108
Linerless pipe markers	70-71	Numbered panels	127
Link	148	Numbering kit	48
Links	147	Numbers & letters	122-126
Lock boards	110	Numbers & Letters DIN A4 size	126
Lock box	112	Numbers & letters: introduction	122
Lockout belt pouch	113	Numbers & letters: sizes	123
Lockout centre	112	Nylon lockout hasp	108
Lockout devices for plug connections	97	Nylon ties	117, 136
Lockout duffel bag	113	O	
Lockout for life DVD	87	OSHA	86
Lockout hasps	108-109	Oversized breaker lockout device	99
Lockout kits	101-103, 108	P	
Lockout satchel	113	Padlock control centre	112
Lockout selection tool	89	Padlock station	112
Lockout starter kit	103	Padlocks	105-107
Lockout stations & lock boxes	110-112	Paper labels on a roll (logistics labelling)	129
Lockout tagout plan	87	Pens	136
Lockout/tagout	85	Permanent marker	115
Lockout/tagout training DVD	87	Photoluminescent area marking	138-141
Lockout/tagout: 9 basic steps	87	Photoluminescent floor marking arrows	140
Lockout/tagout: electrical risk	98	Photoluminescent individual arrows	140
Lockout/tagout: mechanical risk	90	Photoluminescent individual dots	140
Lockout/tagout: what, how & legislation	86	Photoluminescent signs	30
Locks, hasps & accessories	104-109	Photoluminescent stair marking	140
Logistics labeling: why?	120	Pipe banding tape: single colour	78
Logistics labelling	119	Pipe banding tape: two colours	82
Low-location-light-system	60	Pipe marker order form	81
M		Pipe markers: 10-year outdoor usage	80
Machine safety labels	114	Pipe markers: individual markers with die-cut arrowheads	70

Pipe markers: roll form markers	71
Pipe markers: XXL	80
Pipe marking	67
Pipe marking poster	68
Pipe marking: an overview	69
Pipe marking: legislation	68
Plug lockouts	97
Pneumatic quick-disconnect lockout	96
Pocket guides	32
Polyurethane safety bumpers	150
Pouches & bags (lockout)	113
Pouches with magnetic loops	130
Pouches with magnetic strips	130
Prinzing ball valve lockout	91
Prohibition signs	22
Pro-Lock II® cable lockout device	94
Property signs	39
Q	
Quality & material control tags	136
Quality control write-on labels	133
R	
Reflective die-cut cleats (anti-skid)	142
Reflective stripes & solid colour tapes	145
Reflective traffic & works safety signs	35
Removable footprints	146
Roll form pipe markers	71
Roll-mounted tape (anti-skid)	142
S	
Safe condition signs	9
Safety awareness posters	34
Safety bumpers	150
Safety equipment storage solutions	61
Safety lockout	108
Safety lockout hasps	109
Safety management system	117
Safety message tags	117
Safety padlocks	105
Safety poster	4
Safety posters	4
Safety signs	3
Safety signs A5/A4/A3/A2/A1	43
Safety signs material overview	5
Safety signs on rolls	45
Safety signs regulations	4
Safety stop station	61
Safety tag station	116
Safety tags	116
Satchel (lockout)	113
Scissor-Lok™ Lockout Device	94
Self-adhesive safety bumpers	152
Single pole circuit breaker lockout	98
Small adjustable lockout kit	103
Small lockout station	111
Small pouches with magnetic strip	130
Smoking ban	22
Stair markers (photoluminescent)	140
Standard gate valve lockout	92
Statutory & information notices	33
Steel padlocks	105
Storage units for safety equipment	61
Striped tape (anti-skid)	142
Stubby lockout	109
Super strong barricade tape	144

Symbols on rolls	79
T	
Tag holder	116
Tag station	116
Tagout	114
Tape dispensers	143
Traffic signs	35
Transport signs	48
U	
Ultimate lockout kit	101
Ultimate security padlock	107
Underground warning tape	144
Universal multi-pole breaker lockout	98
Universal valve lockout	90
V	
Valve and electrical lockout kit	102
Valve lockout kit	102
Valve lockouts	90-95
Valve marking	84
Valve tags	84
Vandal resistant traffic and property signs	38
Vinyl arrows	146
Vinyl dots	146
Vinyl footprints	146
W	
Wallcharts	32
Warning panels	146
Warning posts & chains	147-148
Warning tags	115
Warning tags: machine related risks	114
Warning tapes	145
Warning tapes & strips (photoluminescent)	141
Warning tapes (photoluminescent)	138, 141
Where to apply pipe markers	69
Works safety signs	35
Write-on labels	135-137
Write-on magnetic labels	131
Write-on markers on card	78
Write-on tags	138
X	
XXL pipe markers	80



Disclaimer

The information contained in this catalogue may be out of date or include omissions, inaccuracies or other errors. Except where expressly provided otherwise in an agreement with Brady Corporation or its subsidiaries, all information is provided “as is” without warranty and conditions of any kind. Brady Corporation hereby disclaims all warranties and conditions with respect to this information, whether express or implied, including the implied warranties of merchantability, fitness for a particular purpose, satisfactory quality and non-infringement.

Surfing www.bradyeurope.com is a simple, efficient and timesaving way to learn more about BRADY products and applications, industry developments, events, promotions, etc. anytime, anywhere.

For looking up technical data sheets, downloading upgrades to your Brady printers and software or fast registration of your Brady products, there's just one address:
www.bradyeurope.com



www.bradyeurope.com



WHEN PERFORMANCE MATTERS MOST™



BRADY Belgium
Industriepark C/3
Lindestraat 20
9240 Zele

Tél. +32 (0) 52 45 78 11
Fax +32 (0) 52 45 78 12

BRADY Denmark
Svendborgvej 39D
5260 Odense S

Tél. +45 66 14 44 00
Fax +45 66 14 44 50

BRADY France
Parc EURO CIT
45, avenue de l'Europe
59436 Roncq Cedex

Tél. +33 (0) 3 20 01 08 70
Fax +33 (0) 3 20 01 08 76

BRADY Germany
Büchenhöfe 2
63329 Egelsbach

Tél. +49 (0) 6103 7598 660
Fax +49 (0) 6103 7598 670

BRADY Hungary
Puskás Tivadar u. 4.
2040 Budaörs

Tél. +36 23 500 275
Fax +36 23 500 276

BRADY Italy
Via Pitagora 18
20128 Milano

Tél. +39 02 26 00 00 22
Fax +39 02 25 75 351

BRADY Middle East
PO BOX 18015
Jebel Ali, Dubai, UAE

Tél. +971 4881 2524
Fax +971 4881 3183

BRADY Norway
Breivika Industrivei 9
6018 Ålesund

Tél. +47 70 13 40 00
Fax +47 70 13 40 01

Brady Slovakia
Na Pántoch 18
831 06 Bratislava

Tél. +421 2 3300 4800
Fax +421 2 3300 4801

BRADY Spain
Carretera de Barcelona, 88
Esc B Entresuelo 9C
08302 Mataro

Tél. +34 900 902 993
Fax +34 900 902 994

Brady Sweden
Vallgatan 5
170 67 Solna

Tél. +46 (0) 8 590 057 30
Fax +46 (0) 8 590 818 68

BRADY Turkey
Selvili Sok. No: 3/4
4. Levent Istanbul 34330

Tél. +90 212 264 02 20 / 264 02 21
Fax +90 212 270 83 19

BRADY UK
Wildmere Industrial Estate
Banbury, Oxon – OX16 3JU

Tél. +44 (0) 1295 228 288
Fax +44 (0) 1295 228 100

BRADY WORLDWIDE

Africa	971-4881-2524
Australia	612-8717-6300
Brazil.....	55-11-3686-4720
Canada.....	1-800-263-6179
China (Beijing)	86-10-6788-7799
China (Shanghai)	86-21-6886-3666
China (Wuxi)	86-510-528-2222
Hong Kong	852-2359-3149
Japan.....	81-45-461-3600
Korea	82-31-451-6600
Latin America.....	1-414-540-5560
Malaysia	60-4-646-2700
Mexico	525-399-6963
New Zealand.....	61-2-8717-2200
Philippines	63-2-658-2077
Singapore	65-6477-7261
Taiwan	886-3-327-7788
Thailand.....	66-2-793-9200
USA.....	1-800-537-8791

Your distributor



Y491383